



**7-INCH ADVANCED AUDIO/VIDEO RECEIVER**

**iLX-507A**

**HALO9 9-INCH ADVANCED AUDIO/VIDEO RECEIVER**

**iLX-F509A**

**HALO11 11-INCH ADVANCED AUDIO/VIDEO RECEIVER**

**iLX-F511A**

- **OWNER'S MANUAL**

Please read before using this equipment.

---

**ALPS ALPINE NORTH AMERICA, INC.**

1500 Atlantic Blvd,  
Auburn Hills, Michigan 48326, U.S.A.  
Phone 1-800-ALPINE-1 (1-800-257-4631)

**ALPINE ELECTRONICS OF AUSTRALIA PTY. LIMITED**

161-165 Princes Highway,  
Hallam Victoria 3803, Australia  
Phone 03-8787-1200

**ALPS ALPINE EUROPE GmbH**

Ohmstrasse 4, 85716 Unterschleissheim, Germany  
Phone: +49 (0) 89-32 42 640  
For contact information on your respective country,  
please visit [www.alpine-europe.com](http://www.alpine-europe.com).

**ALPS ALPINE EUROPE GmbH**

Aurora House, Deltic Avenue  
Rooksley, Milton Keynes, MK13 8LW  
United Kingdom  
Phone: 0345-313-1640

**ALPS ALPINE ASIA CO., LTD.**

The 9th Towers, Tower B, 24th Floor, Unit TNB01-03,  
33/4 Rama 9 road, Huay Kwang, Bangkok, 10310, Thailand  
Phone +66 (2) 090 9596

**ALPS ALPINE CO., LTD.**

20-1 Yoshima Industrial park,  
Iwaki, Fukushima, Japan 970-1192  
Phone 0246-36-4111



## CONTENTS

### Operating Instructions

#### WARNING

Points to Observe for Safe Usage .....	7
<b>WARNING</b> .....	<b>7</b>
<b>CAUTION</b> .....	<b>8</b>
<b>NOTICE</b> .....	<b>8</b>

#### Getting Started

Location of Controls .....	10
Turning Power On or Off.....	11
Adjusting the Volume .....	11
Lowering Volume Quickly .....	11
Turning off the screen/button illumination (Display OFF) .....	11
Touch Screen Operation .....	11
Switching Sources.....	12
Selecting an Item in a List .....	12
About the HOME Screen.....	12
About the Indicator Display .....	13

#### Setup

Setup Operation .....	14
-----------------------	----

#### Device Setup

Displaying Device List.....	14
Pairing the Bluetooth® Device.....	15
Connecting the Device Registered in the Device List .....	15
Disconnecting the Connected Device.....	15
Deleting a Bluetooth Device from the list.....	15
Wi-Fi Setup.....	16
Setting the Wi-Fi Mode .....	16
Connecting to Wi-Fi Access Point.....	16
Changing the Wi-Fi password of the unit.....	17
Bluetooth Setup.....	18
Setting the Bluetooth.....	18
Setting the Auto Connection.....	18
Setting the PIN Code.....	18
Displaying Device Information.....	18

#### Function Setup

Apple CarPlay Setup.....	18
Adjusting the Media Level.....	18
Adjusting the Phone Calls Volume .....	19
Adjusting the Ringtones and Alerts Level.....	19
Adjusting the Notifications and Guidance Level .....	19
Adjusting the Voice Recognition Level .....	19
Adjusting the Microphone Level.....	19
Android Auto Setup .....	19
Adjusting the Media Level.....	19
Adjusting the Phone Calls Volume .....	19
Adjusting the Ringtones and Alerts Level.....	19
Adjusting the Notifications and Guidance Level .....	20
Adjusting the Voice Recognition Level .....	20
Adjusting the Microphone Level.....	20
Radio Setup .....	20
Adjusting the Radio Volume .....	20
Adjusting the Interrupt Volume.....	20
Setting the TA/Traffic Interrupt .....	20
Setting the News Interrupt.....	20
Setting the PTY31/Alarm Interrupt.....	20
Setting the PTY Seek Item .....	20
Setting the RDS Regional Mode .....	21
PI SEEK Setting .....	21
Turning AF (Alternative Frequencies) On or Off .....	21
Setting the DAB Antenna ON/OFF.....	21
USB Setup .....	21
Adjusting the USB Volume.....	21
Video Setup.....	21
iPod Setup.....	22
Adjusting the iPod Volume.....	22
AUX (Auxiliary) Setup.....	22
Adjusting the AUX Volume .....	22
Setting the Auxiliary (AUX) Name .....	22
Video Setup.....	22
HDMI Setup .....	23
Adjusting the HDMI Volume .....	23
Setting the HDMI Name.....	23
Video Setup.....	23
Setting the HDMI Selector .....	23
Phone Setup.....	23
Adjusting the Ringtone Volume .....	23

Adjusting the Phone Calls Volume .....	24
Adjusting the Microphone Level .....	24
Setting the Phonebook Transfer .....	24
Setting the Phonebook Name Order .....	24
Setting the Phonebook Calendar.....	24
Bluetooth Audio Setup .....	24
Adjusting the Bluetooth Audio Volume.....	24
CAN I/F BOX Setting .....	24
Setting the Climate Screen Interrupt Time .....	24
Setting the Parking Sensor Interrupt	
On/Off.....	25
Camera Setup .....	25
Setting the Reverse Camera (Camera 1) .....	25
Reverse Camera Signal Input Setting .....	25
Camera 2 Setup .....	25
Camera 2 Signal Input Setting.....	25
Camera Selector Setup.....	25
Camera Guide Setup .....	26
Video Setup .....	26
Setting the Mute while Reversing.....	27
TIDAL Setup.....	27
Confirm Login User Name.....	27
Setting the Streaming Quality.....	27
Adjusting the TIDAL Volume .....	27
Logging out of TIDAL.....	27
Navigation Setup.....	27
Navigation interrupt setting .....	27

## System Setup

Adjusting the Key Sound.....	28
Setting the Microphone Effect .....	28
Language Setup .....	29
Adjusting the Clock .....	29
Setting the Time Format.....	29
Setting the Time Zone.....	29
Setting the Daylight Savings Time.....	29
Setting the Home Screen Type.....	29
Screen/Lighting Setup .....	29
Setting the Brightness of the Backlighting	
(Dimmer).....	29
Adjusting the Dimmer of Button Lighting at	
Night.....	29
Adjusting the Minimum Level of Backlight .....	29
Switching the Display Colour.....	30
Editing HOME screen .....	30
Setting Security Code .....	30
Setting the password.....	30
Clearing the password .....	30
Vehicle Type Setup.....	30

Steering wheel Setting.....	30
Fuel Type Setting.....	30
EV Connector Type Setting.....	30
Audio Leveling .....	31
Installation Setup .....	31
About iLX-507A/iLX-F509A/	
iLX-F511A.....	31
Displaying the Product Information.....	31
Updating Firmware Version.....	31
Dedicated Tuning According to Your Car	
(Car by Car Update).....	31
Displaying Software License.....	32
Initialising the Sound Settings .....	32
Initialising the System .....	32

## Sound Setup

Setting the Media Xpander (MX).....	33
Equalizer Settings.....	33
Adjusting the Parametric Equalizer Curve	
(Advanced EQ/Basic EQ).....	33
Equalizer Presets (Preset EQ).....	34
Fader/Balance/Rear Speaker/Subwoofer	
Settings.....	34
Setting the Fader/Balance .....	34
Rear Speaker Setting.....	34
Turning Subwoofer ON/OFF .....	34
Time Correction Settings.....	35
Crossover Settings (X-OVER) .....	35
Setting the "bass engine" .....	36
Adjusting Bass Level/Treble Level .....	36
Setting the Subwoofer .....	36
Adjusting the Subwoofer Level.....	36
Setting the Subwoofer Phase .....	37
Setting the Navigation .....	37
Adjusting the Navigation Volume.....	37
Adjusting the Background Audio Volume .....	37
Defeat Setting.....	37
About the Crossover .....	37
About Time Correction .....	38

## Apple CarPlay (Optional)

Access to Apple CarPlay.....	39
Using Voice Recognition function.....	39

## Android Auto (Optional)

What is Android Auto .....	40
Activate Android Auto.....	40
Using Voice Recognition function.....	40

## Radio/RDS

### Radio Basic Operation

Listening to the Radio .....	41
Presetting Stations Manually .....	41
Presetting Stations Automatically.....	42
Tuning to Preset Station .....	42

### RDS Operation

Turning AF (Alternative Frequencies) On or Off .....	42
Interruption Function .....	42
Receiving Traffic Announcement.....	43
Displaying Radio Text .....	43

## DAB/DAB+

Listening to DAB/DAB+/DMB .....	44
Presetting Service .....	44
Tuning to Preset Service .....	44
Service Component/PTY Search Function.....	44
Service Search Function .....	44
PTY Search Function .....	44
Interruption Function .....	45
Receiving Traffic Announcement.....	45
Displaying DAB Text .....	45
Displaying the Slide Show by Enlarging .....	45
About DAB/DAB+/DMB .....	45

## USB Flash drive (Optional)

### USB Audio

Playback.....	47
Repeat Play.....	47
Shuffle Play.....	47
Searching for a Desired Song.....	48

### USB Video

Playback.....	49
Fast-forwarding/Fast-reversing .....	49
Repeat Play.....	49
Shuffle Play.....	49
Searching for a Desired file.....	49
Switching Display Modes .....	50
Switching the Audio Tracks .....	50

## iPod mode on iPhone (Optional)

Playback.....	51
Searching for a Music File.....	51
Repeat Play.....	52

Shuffle Play .....	52
--------------------	----

## HDMI Device (Optional)

HDMI Operation.....	53
Switching the HDMI Input .....	53
Switching Display Modes .....	54

## Bluetooth Operation

Setup Before Using .....	54
About Bluetooth.....	54
About the Hands-free Phone.....	54
Before Using Bluetooth.....	55

### Hands-free Phone Control

Answering a Call .....	55
Hanging up the Telephone.....	56
Calling.....	56
Making a phone call using the Phone Menu .....	56
Phone Operation Screen .....	56
Adjusting the Speech Volume.....	56
Changing the Voice Output.....	57
Muting the Microphone .....	57
DTMF (Touch-Tone) Function .....	57
Phone Book Function .....	57
Searching in the Phone Book .....	57
Synchronising the Phone Book.....	57
Deleting the Phone Book Entries .....	57

### Bluetooth Audio

Playback.....	58
Repeat Play .....	58
Shuffle Play .....	59
Searching for a Desired file.....	59
Connecting a Bluetooth Device.....	59
Disconnecting the Bluetooth Connection.....	59
Switching the connecting Bluetooth Device .....	59

## TIDAL Operation (Optional)

Logging in to TIDAL.....	60
Playback.....	61
Adding to the Preset List .....	61
Recalling from the Preset List .....	61
Repeat Play .....	61
Shuffle Play .....	61
Search.....	62
Search from My Collection.....	62
Displaying the Playlist .....	62

Adding to Favourite Category .....	63
Adding to Playlists .....	63
Search for Content Related to the Track Being Played.....	63
Search for Content Related to the Artist Being Played.....	64

## Auxiliary Device (Optional)

Operating Auxiliary Devices (Optional) .....	64
Switching Display Modes .....	65

## Camera Operation (Optional)

Rear Camera Operation.....	65
Displaying the rear view video while the car is in reverse .....	65
Displaying the Camera Image from the HOME screen .....	66
Guide Display ON/OFF Setting.....	66
Adjusting the Caution Display Location .....	66
Hitch Guide Display ON/OFF Setting .....	66
About the Rear Camera Guide.....	67
Switching the Image Pattern for the Rear Camera .....	68
Front Camera Operation.....	69
Displaying the Camera Image from the HOME screen .....	69
Switching the Image Pattern for the Front Camera .....	69
About the adjustment of guide display ON/OFF setting and adjustment of Caution display location .....	69
Side Camera Operation.....	69
About the adjustment of guide display ON/OFF setting and adjustment of Caution display location .....	69

## About Vehicle Interlock Function

Access to Vehicle Info Mode.....	70
About Parking Sensor screen.....	70
About Car Setting screen .....	71

## Information

Product Software Update.....	71
About the Supported Formats .....	71
About MP3/WMA/AAC/FLAC/WAV/APE .....	71
In Case of Difficulty.....	73
If this Message Appears .....	74
Specifications.....	75

# Installation and Connections

<b>WARNING</b> .....	77
<b>CAUTION</b> .....	77
<b>Precautions</b> .....	78
Accessory List .....	78
Installation.....	78
Caution concerning the installation location.....	79
Mounting the Microphone.....	79
Mounting the GPS Antenna inside the vehicle.....	79
Note on using HDMI Connection Cables.....	79
Position Adjustment and Mounting Dimensions of the Display (iLX-F509A/iLX-F511A only) .....	80
Adjusting the display position (iLX-F509A/iLX-F511A) .....	81
Installation example using the Original Mounting Bracket.....	81
Adjust the up-down position of the Display unit (iLX-F509A/iLX-F511A).....	82
Install the display unit (iLX-F509A/iLX-F511A) .....	82
Connections.....	84
Connection 1 .....	84
Connection 2 .....	85
If an ACC power supply is not available .....	87
System Example.....	88

# Operating Instructions

## WARNING

### Points to Observe for Safe Usage

- Read this manual carefully before using this system components. They contain instructions on how to use this product in a safe and effective manner. Alpine cannot be responsible for problems resulting from failure to observe the instructions in this manual.
- This manual uses various pictorial displays to show you how to use this product safely and to alert you to potential dangers resulting from improper connections and operation. Following are the meanings of these pictorial displays. It is important to fully understand the meanings of these pictorial displays in order to use this manual and the system properly.
- This product may be used with software applications. Please follow all usage instructions and warnings when using this product at all times. Do not use this product or any software application in a manner which will hinder safe operation of your vehicle.

## WARNING

- Operation of the system while driving is dangerous. Users should stop vehicle before operating the software.
- Road conditions and regulations take precedence over information contained on the map display: observe actual traffic restrictions and circumstances while driving.
- This software is designed for use exclusively in the unit. It cannot and may not be used in conjunction with other hardware.

## WARNING

This symbol means important instructions. Failure to heed them can result in serious injury or death.

### **INSTALL THE PRODUCT CORRECTLY SO THAT THE DRIVER CANNOT WATCH TV/VIDEO UNLESS THE VEHICLE IS STOPPED AND THE PARKING BRAKE IS APPLIED.**

It is dangerous for the driver to watch TV/Video while driving a vehicle. Installing this product incorrectly enables the driver to watch TV/Video while driving. This may cause a distraction, preventing the driver from looking ahead, thus causing an accident. The driver or other people could be severely injured.

### **DO NOT WATCH VIDEO WHILE DRIVING.**

Watching the video may distract the driver from looking ahead of the vehicle and cause an accident.

### **DO NOT OPERATE ANY FUNCTION THAT TAKES YOUR ATTENTION AWAY FROM SAFELY DRIVING YOUR VEHICLE.**

Any function that requires your prolonged attention should only be performed after coming to a complete stop. Always stop the vehicle in a safe location before performing these functions. Failure to do so may result in an accident.

### **KEEP THE VOLUME AT A LEVEL WHERE YOU CAN STILL HEAR OUTSIDE NOISES WHILE DRIVING.**

Excessive volume levels that obscure sounds such as emergency vehicle sirens or road warning signals (train crossings, etc.) can be dangerous and may result in an accident. LISTENING AT LOUD VOLUME LEVELS IN A CAR MAY ALSO CAUSE HEARING DAMAGE.

### **MINIMIZE DISPLAY VIEWING WHILE DRIVING.**

Viewing the display may distract the driver from looking ahead of the vehicle and cause an accident.

### **DO NOT DISASSEMBLE OR ALTER.**

Doing so may result in an accident, fire or electric shock.

### **USE ONLY IN CARS WITH A 12 VOLT NEGATIVE GROUND.**

(Check with your dealer if you are not sure.) Failure to do so may result in fire, etc.

### **KEEP SMALL OBJECTS SUCH AS SCREWS OUT OF THE REACH OF CHILDREN.**

Swallowing them may result in serious injury. If swallowed, consult a physician immediately.

### **USE THE CORRECT AMPERE RATING WHEN REPLACING FUSES.**

Failure to do so may result in fire or electric shock.

### **DO NOT BLOCK VENTS OR RADIATOR PANELS.**

Doing so may cause heat to build up inside and may result in fire.

### **USE THIS PRODUCT FOR MOBILE 12V APPLICATIONS.**

Use for other than its designed application may result in fire, electric shock or other injury.

### **MAKE THE CORRECT CONNECTIONS.**

Failure to make the proper connections may result in fire or product damage.

### **BEFORE WIRING, DISCONNECT THE CABLE FROM THE NEGATIVE BATTERY TERMINAL.**

Failure to do so may result in electric shock or injury due to electrical shorts.

---

**DO NOT ALLOW CABLES TO BECOME ENTANGLED IN SURROUNDING OBJECTS.**

Arrange wiring and cables in compliance with the manual to prevent obstructions when driving. Cables or wiring that obstruct or hang up on places such as the steering wheel, gear lever, brake pedals, etc. can be extremely hazardous.

---

**DO NOT SPLICE INTO ELECTRICAL CABLES.**

Never cut away cable insulation to supply power to other equipment. Doing so will exceed the current carrying capacity of the wire and result in fire or electric shock.

---

**DO NOT DAMAGE PIPE OR WIRING WHEN DRILLING HOLES.**

When drilling holes in the chassis for installation, take precautions so as not to contact, damage or obstruct pipes, fuel lines, tanks or electrical wiring. Failure to take such precautions may result in fire.

---

**DO NOT USE BOLTS OR NUTS IN THE BRAKE OR STEERING SYSTEMS TO MAKE GROUND CONNECTIONS.**

Bolts or nuts used for the brake or steering systems (or any other safety-related system), or tanks should NEVER be used for installations or ground connections. Using such parts could disable control of the vehicle and cause fire etc.

---

**DO NOT INSTALL IN LOCATIONS WHICH MIGHT HINDER VEHICLE OPERATION, SUCH AS THE STEERING WHEEL OR SHIFT LEVER.**

Doing so may obstruct forward vision or hamper movement etc. and results in serious accident.

 **CAUTION**

This symbol means important instructions. Failure to heed them can result in injury or material property damage.

---

**HALT USE IMMEDIATELY IF A PROBLEM APPEARS.**

Failure to do so may cause personal injury or damage to the product. Return it to your authorized Alpine dealer or the nearest Alpine Service Center for repairing.

---

**HAVE THE WIRING AND INSTALLATION DONE BY EXPERTS.**

The wiring and installation of this unit requires special technical skill and experience. To ensure safety, always contact the dealer where you purchased this product to have the work done.

---

**USE SPECIFIED ACCESSORY PARTS AND INSTALL THEM SECURELY.**

Be sure to use only the specified accessory parts. Use of other than designated parts may damage this unit internally or may not securely install the unit in place. This may cause parts to become loose resulting in hazards or product failure.

---

**ARRANGE THE WIRING SO IT IS NOT CRIMPED OR PINCHED BY A SHARP METAL EDGE.**

Route the cables and wiring away from moving parts (like the seat rails) or sharp or pointed edges. This will prevent crimping and damage to the wiring. If wiring passes through a hole in metal, use a rubber grommet to prevent the wire's insulation from being cut by the metal edge of the hole.

---

**DO NOT INSTALL IN LOCATIONS WITH HIGH MOISTURE OR DUST.**

Avoid installing the unit in locations with high incidence of moisture or dust. Moisture or dust that penetrates into this unit may result in product failure.

---

 **NOTICE**

---

**Product Cleaning**

Use a soft dry cloth for periodic cleaning of the product. For more severe stains, please dampen the cloth with water only. Anything else has the chance of dissolving the paint or damaging the plastic.

---

**Temperature**

Be sure the temperature inside the vehicle is between +45°C (+113°F) and 0°C (+32°F) before turning your unit on.

---

**Maintenance**

If you have problems, do not attempt to repair the unit yourself. Return it to your Alpine dealer or the nearest Alpine Service Station for servicing.

---

**Protecting the USB connector**

- Only an iPhone or USB flash drive can be connected to the USB connector on this unit. Correct performance using other USB products cannot be guaranteed.
- If the USB connector is used, be sure to use only the supplied connector cable with the unit. A USB hub is not supported.
- Depending on the connected USB flash drive, the unit may not function or some functions may not be performed.
- The audio file formats that can be played on the unit is MP3/WMA/AAC/FLAC/WAV/APE.
- Artist/song name, etc., can be displayed. Certain, special characters may not be correctly displayed.



## CAUTION

Alpine accepts no responsibility for lost data, etc., even if data, etc., is lost while using this product.

### On Handling USB Flash drive

- This unit can control a memory storage device that supports the USB Mass Storage Class (MSC) protocol. Playable audio file formats are MP3, WMA, AAC, FLAC, WAV and APE.
- USB Flash drive function is not guaranteed. Use a USB flash drive according to the terms of agreement. Read the USB flash drive Owner's Manual thoroughly.
- Avoid usage or storage in the following locations: Anywhere in the car exposed to direct sunlight or high temperatures. Anywhere the possibility of high humidity or corrosive substances are present.
- Fix the USB flash drive in a location where driver operation will not be hindered.
- USB Flash drive may not function correctly at high or low temperature.
- Use only certified USB flash drive. Note that even certified USB flash drive, may not function correctly depending on its type or state.
- Depending on the settings of the USB flash drive type, memory state or encoding software, the unit may not play back or display properly.
- USB Flash drive may take time to start playback. If there is a particular file other than audio in the USB flash drive, it may take considerable time before the file is played back or searched.
- The unit can play back "mp3," "wma," "m4a," "flac," "fla," "wav," and "ape" file extensions.
- Do not add the above extensions to a file other than audio data. This non-audio data will not be recognized. The resulting playback may contain noise that can damage speakers and/or amplifiers.
- It is recommended to back up important data on a personal computer.
- Do not remove the USB device while playback is in progress. Change SOURCE to something other than USB, then remove the USB device to prevent possible damage to its memory.

- Windows Media, and the Windows logo are trademarks, or registered trademarks of Microsoft Corporation in the United States and/or other countries.
- Apple, iPhone, iPod, Lightning and Siri are trademarks of Apple Inc., registered in the U.S. and other countries. Apple CarPlay is a trademark of Apple Inc.
- Use of the Made for Apple and Works with Apple badges means that an accessory has been designed to connect specifically to the Apple product(s) identified in the Made for Apple badge and to work specifically with the technology identified in the Works with Apple badge, and has been certified by the developer to meet Apple performance standards. Apple is not responsible for the operation of this device or its compliance with safety and regulatory standards. Please note that the use of this accessory with an Apple product may affect wireless performance.
- Use of the Apple CarPlay logo means that a vehicle user interface meets Apple performance standards. Apple is not responsible for the operation of this vehicle or its compliance with safety and regulatory standards. Please note that the use of this product with iPhone may affect wireless performance.
- Google, Android, Google Play and Android Auto are trademarks of Google LLC. To use Android Auto on your car display, you'll need an Android phone running Android 6.0 or higher, an active data plan, and the Android Auto app.
- The terms HDMI and HDMI High-Definition Multimedia Interface, and the HDMI Logo are trademarks or registered trademarks of HDMI Licensing Administrator, Inc. in the United States and other countries.
- The Bluetooth® word mark and logos are registered trademarks owned by Bluetooth SIG, Inc. and any use of such marks by ALPS ALPINE Co., LTD. is under license. Other trademarks and trade names are those of their respective owners.
- The Wi-Fi CERTIFIED™ Logo is a registered trademark of Wi-Fi Alliance®.
- LDAC and LDAC logo are trademarks of Sony Corporation.
- The product with this logo is conformed to High-Resolution Audio standard defined by Japan Audio Society. This logo is used under license from Japan Audio Society.
- MQA and the Sound Wave Device are registered trade marks of MQA Limited © 2016.

Made for iPhone SE (2nd generation), iPhone 11 Pro Max, iPhone 11 Pro, iPhone 11, iPhone XS Max, iPhone XS, iPhone XR, iPhone X, iPhone 8 Plus, iPhone 8, iPhone 7 Plus, iPhone 7, iPhone SE, iPhone 6s Plus, iPhone 6s.

# Getting Started

## Location of Controls

### ■ iLX-507A

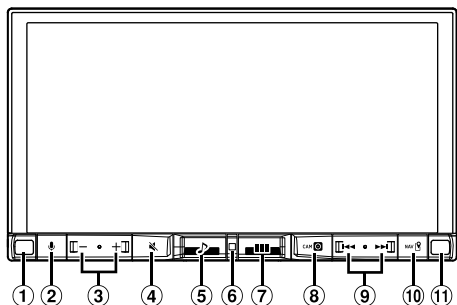

### ■ iLX-F509A/iLX-F511A

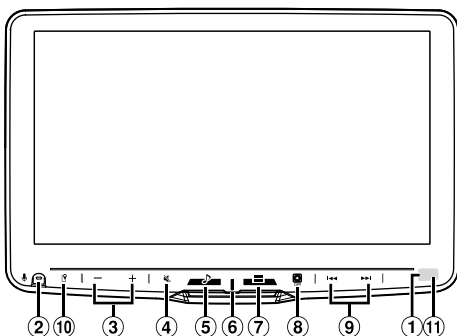

#### ① Dimmer Sensor

Senses the brightness of the car interior.

#### ② **🎤 button**

Activate Siri function or voice recognition mode while Apple CarPlay or Android Auto is connected.

#### ③ **- / + (DOWN/UP) button**

Adjusts the volume.

#### ④ **🔇 (MUTE) button**

Activates/deactivates MUTE mode. Press and hold this button for at least 2 seconds to turn off the screen/button illumination.

#### ⑤ **🎵 (Audio) button**

Displays the Audio playback screen. Audio sources can be switched while the Audio playback screen is displayed.

- When displaying a screen different from the audio source (such as the map screen for Apple CarPlay or Android Auto), the audio source is switched without changing the screen display.

#### ⑥ **Power indicator**

#### ⑦ **🏠 (HOME) button**

Displays the HOME screen. The Sound Setup screen is displayed while the HOME screen is displayed. Press and hold this button for at least 2 seconds to turn the power off.

#### ⑧ **(CAM) button**

Displays the image of Camera2 (Rear/Front/Side/Other) or Camera1 (Rear). Press for 1 second or more to return to the previous screen.

#### ⑨ **⏮ / ⏭ button**

Press to seek up/down a station in radio mode or up/down a track, etc., in other audio/visual sources.

#### ⑩ **📍 (MAP) button**

Displays the map screen for Apple CarPlay / Android Auto when Apple CarPlay or Android Auto is connected. Displays the navigation map screen when the optional Navigation Stick (KTX-NS01AU) is connected.

#### ⑪ **Remote Sensor**

Point the remote control transmitter towards the remote sensor within a range of 2 meters.

### About the button descriptions used in this Owner's Manual

The buttons found on the face of the unit are expressed in bold (e.g. **🏠 (HOME)**). The buttons found on the touch-screen display are shown in bold within brackets, [ ] (e.g. **[OK]**).

### ⚠ CAUTION

#### ■ iLX-F509A/iLX-F511A only

To adjust the display angle, hold the center of the top and bottom of the display to move it. To protect the display, do not hold the left and right ends to move it.

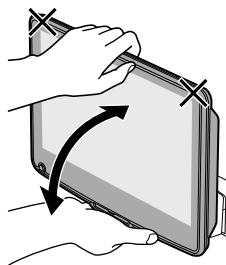

---

## Turning Power On or Off

---

When the ignition key is turned to ACC or ON, the opening screen will be automatically displayed.

### 1 Turn the ignition key to the ACC or ON position.

The unit turns on.

- When using the system for the first time, the HOME screen is displayed.
- When turned on, the unit displays the last screen that was displayed before the ignition key was turned off. For example, if the unit is in radio mode when ignition is turned off, it will remain in radio mode when ignition is turned back on.

### 2 To turn the unit to off, turn the ignition key to the OFF position.

- *The unit is a precision device. Careful handling of the unit should provide you with years of trouble-free operation.*
- *Some of this unit's functions cannot be performed while the vehicle is in motion. Be sure to stop your vehicle in a safe location and apply the parking brake before attempting these operations.*

---

## Adjusting the Volume

---

### Adjust the volume by touching – / +.

Volume decreases/increases continuously by touching and holding – / +.

Volume: 0 to 35

---

## Lowering Volume Quickly

---

Audio Mute function instantly lowers the volume level to 0.

### 1 Press the (MUTE) button to activate MUTE mode.

The audio level will be 0 and the mute indicator will flash.

### 2 Press the (MUTE) button again to bring the audio back to previous volume level.

---

## Turning off the screen/button illumination (Display OFF)

---

You can turn off the screen and button illumination without changing the audio output.

### 1 Press and hold the (MUTE) button for at least 2 seconds.

The screen/button illumination is turned off.

### 2 To cancel Display OFF mode, press and hold the (MUTE) button for at least 2 seconds or touch the screen.

- *When there is an interrupt such as an incoming hands-free call, Display OFF is canceled.*

---

## Touch Screen Operation

---

You can operate the unit by using the touch panel display.

- *Be sure to touch the onscreen button lightly with the pad of your finger to avoid scratching the display.*

### Touch operation

Touch a button or list item on the screen lightly.



- *If you touch a button and there is no reaction, lift your finger.*
- *Onscreen buttons that cannot be operated are dimmed.*

### Swipe operation (Enhanced Text Mode only)

Move your finger lightly with a swipe.



## Switching Sources

### 1 Press the (HOME) button.

The HOME screen is displayed.



### 2 Touch your desired source icon.

- You can change the audio source icon location on the screen. For details, see “Editing HOME screen” (page 30).

## Selecting an Item in a List

To scroll through a list, perform the following operations.

### Touch the screen and slide your finger up and down.

The screen will scroll along with your finger movement.

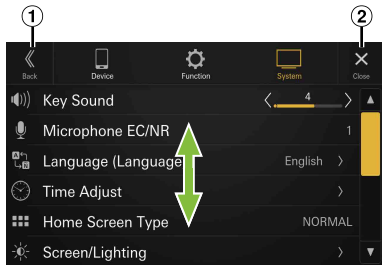

① Returns to the previous screen.

② Closes the window.

- After touching the screen, move your finger away from the screen before dragging and that item will be selected.

## About the HOME Screen

In the HOME screen, select the audio source to perform various settings and operations of the function.

- The HOME screen can be switched between Normal mode and Enhanced Text mode. For details, see “Setting the Home Screen Type” (page 29).

### Press the (HOME) button.

The HOME screen is displayed.

### ■ Normal mode screen example

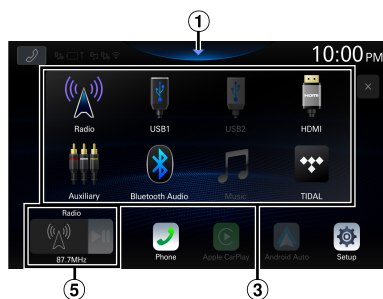

### ■ Enhanced Text mode screen example



① Touch to display the Sound Setup screen.

- The Sound Setup screen can also be displayed by pressing the  (HOME) button while the HOME screen is displayed.

② Touch to change the page.

- Pages can also be changed by swiping the HOME screen horizontally with your finger.

③ Audio source select area

Touch your desired source icon to change the audio source.

- The order of source icons can be changed. For details, see “Editing HOME screen” (page 30).

④ HOME screen navigation

⑤ Thumbnail window for the current source

Source name, artwork and title information are displayed. Touch the artwork to display the source screen. Touch  to play/pause a track or video.

## About the Indicator Display

The Indicator Bar at the top of the screen displays various types of information, like the current time.



### ① Phone shortcut button

The Device List screen is displayed when a Phone, CarPlay or Android Auto device is not connected. The hands-free phone screen (Recent Call, Phone Book, Keypad) is displayed when the hands-free phone is connected. The screen of the previous logout is displayed.

The Apple CarPlay screen is displayed while Apple CarPlay is connected.

The Android Auto screen is displayed while Android Auto is connected.

### ② Lights up when connecting the hands-free phone ① via Bluetooth. (Does not display when connection is set to OFF.)

### ③ Indicates the battery level of the connected hands-free phone ①.

No Battery	Level 1	Level 2	Level 3	Level 4	Level 5

• This may not be displayed for the hands-free phone ②.

### ④ Indicates the Bluetooth signal strength level of the connected hands-free phone ①.

Displayed when Bluetooth setting is ON.

0	1	2	3	4	5

• This may not be displayed for the hands-free phone ②.

### ⑤ Lights up when connecting the audio device via Bluetooth. (Does not display when connection is set to OFF.)

### ⑥ Lights up when connecting the hands-free phone ② via Bluetooth. (Does not display when connection is set to OFF.)

### ⑦ Indicates a Wi-Fi signal strength level when connected to a Wi-Fi access point with a valid internet connection.

0	1	2	3	4

### ⑧ Lights up when connecting a separately sold ALPINE KNOB (RUE-BK01A ) via Bluetooth. You can use RUE-BK01A to adjust the volume level of this unit or switch the camera on or off. For details, refer to the Owner's Manual of RUE-BK01A .

### ⑨ Indicates the current time. Touch to turn ON/OFF the clock display. You can switch between the 12 hour display and 24 hour display options (page 29).

# Setup

## Setup Operation

### 1 Press the (HOME) button.

The HOME screen is displayed.



[Setup] button

### 2 Touch [Setup].

The Settings menu screen is displayed.

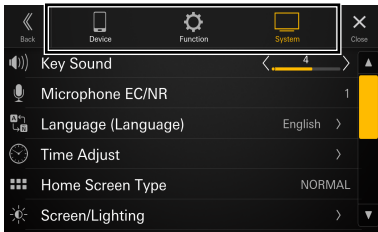

### 3 Touch the required setting category on the upper part of the Settings menu screen, and then touch the setting item.

**Setting categories:**

Device: See "Device Setup" (page 14)

Function: See "Function Setup" (page 18)

System: See "System Setup" (page 28)

# Device Setup

[Device] is selected on the Settings menu screen.

### ■ Device Setup Menu screen

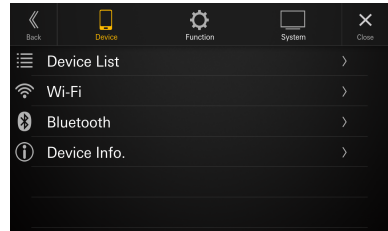

**Setting items:**

Device List (page 14)

Wi-Fi (page 16)

Bluetooth (page 18)

Device Info. (page 18)

## Displaying Device List

[Device List] is selected on the Device Setup menu screen.

The list of devices registered or connected to this unit is displayed. 10 devices compatible with Bluetooth and Wi-Fi, and 1 device compatible with Apple CarPlay or Android Auto connected via USB, can be displayed.

### ■ Device List screen example

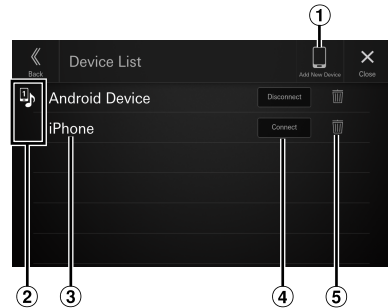

#### ① Add New Device

Search for Bluetooth compatible devices. For details, see "Pairing the Bluetooth Device" (page 15).

#### ② Function icon

: Hands Free1

: Hands Free2

: Bluetooth Audio

: Hands Free1 + Bluetooth Audio

: Hands Free2 + Bluetooth Audio

: Apple CarPlay

: Android Auto

- ③ Device Name or Device Address
- ④ Connect or disconnect the selected device. For details, see “Connecting the Device Registered in the Device List”, “Disconnecting the Connected Device” (page 15).
- ⑤ Delete the selected device information. For details, see “Deleting a Bluetooth Device from the list” (page 15).

## Pairing the Bluetooth® Device

Search for Bluetooth compatible devices.

### Setting item:

Add New Device

### 1 Touch [Add New Device].

A search for devices to connect wirelessly to the unit starts.

The Search List is displayed, and the list of searched devices is displayed.

### 2 Touch a device to connect in the list.

### 3 When a code is displayed on the device, check that the code is the same as the one on the screen of the unit, and touch [Yes].

When the device connection is complete, a message appears and the device returns to normal mode.

## Connecting the Device Registered in the Device List

Select one of 10 paired Bluetooth or Wi-Fi compatible devices that you previously registered.

- If you want to use Apple CarPlay or Android Auto with a wireless connection, set the “Wi-Fi Mode” setting to [Phone Link Mode]. For details, see “Setting the Wi-Fi Mode” (page 16). Also, set the Wi-Fi function of your iPhone or Android smartphone to “On”.

### 1 Touch [Connect] of the device you want to connect from the Paired Device list.

The Function Select screen is displayed.

### 2 Select the function of the connecting device on the Select Function screen, and touch [OK].

A check mark is displayed for the selected function.

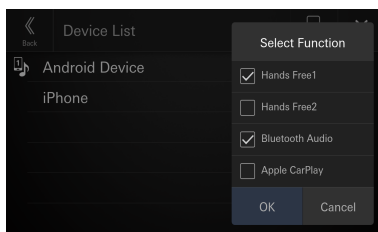

Hands Free1: The device is used as the first hands-free phone or Android Auto.

Hands Free2: The device is used as the second hands-free phone or Android Auto.

Bluetooth Audio: The device is used as an Bluetooth Audio device.

Apple CarPlay\*: The device is used as Apple CarPlay.

Android Auto\*: The device is used as Android Auto.

\* If you want to use Apple CarPlay or Android Auto mode without displaying [Apple CarPlay] or [Android Auto] on the Select Function screen, select [Hands Free1] or [Hands Free2] to connect your device.

- For example, when the device is used as a hands-free phone and Bluetooth Audio, select [Hands Free1] and [Bluetooth Audio].

When the device connection is complete, a message appears and the device returns to normal mode.

## Disconnecting the Connected Device

### Touch [Disconnect] of the device you want to disconnect from the Paired Device list.

The device is disconnected.

## Deleting a Bluetooth Device from the list

You can delete the information of a previously connected Bluetooth compatible device.

### 1 Touch [Delete] of the Bluetooth compatible device to delete from the Paired Device list.

### 2 Touch [Yes].

- Touching [No] will cancel the setting.

## Wi-Fi Setup

[Wi-Fi] is selected on the Device Setup menu screen.

### Setting the Wi-Fi Mode

Set the Wi-Fi mode according to the environment in which Wi-Fi is used.

**Setting item:**

Wi-Fi Mode

**Setting contents:**

OFF (Initial setting) / Internet Mode / Phone Link Mode

OFF: Wi-Fi is Off.

Internet Mode: Select this item when connecting to a Wi-Fi access point with an internet connection to update software or use TIDAL.

When the Internet Mode is selected, the Wi-Fi Management setting is enabled. For details, see “Connecting to Wi-Fi Access Point” (page 31).

Phone Link Mode: Select this item to use Apple CarPlay or Android Auto with a wireless connection.

When the Phone Link Mode is selected, the PSK for Phone Link setting is enabled. For details, see “Changing the Wi-Fi password of the unit” (page 17).

- *Wireless Apple CarPlay and Android Auto are not available when the Internet Mode is selected. If you want to use a device that works with an internet connection (such as TIDAL) and Apple CarPlay/Android Auto at the same time, connect your iPhone or smartphone via USB.*

### Connecting to Wi-Fi Access Point

To update the software of this product or use TIDAL, it is necessary to connect to a Wi-Fi access point with a valid internet connection.

- *Available only when “Wi-Fi Mode” setting is [Internet Mode] (page 16).*

\* Data rates may apply. Please check with your carrier for details.

**Setting item:**

Wi-Fi Management

### 1 Touch to select [Wi-Fi Management].

The Wi-Fi Access Point List screen is displayed.

### 2 Touch to select [Search].

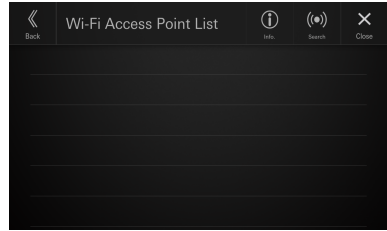

Search for the Wi-Fi access point. Once the search is finished, the Wi-Fi New Access Points List screen is displayed.

- The connected access points are not displayed on the search screen.

### 3 Touch to select the access point in the list to connect.

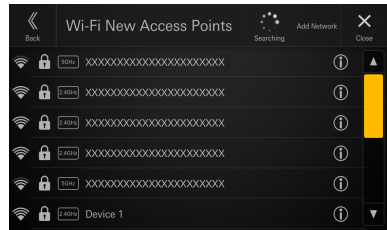

The password input screen is displayed.

- When you touch [Add Network] on the Wi-Fi New Access Points screen, you can connect to a new access point by manually entering the SSID, security and password for the access point. 1 to 32 characters can be input for the SSID, and 8 to 64 characters for the password. If [None] is entered for security, password input is not required.

### 4 Enter a password, then touch to select [DONE].

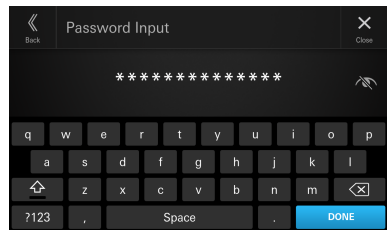

- Touch [X] to delete an entered number.



## 5 Touch to select [OK].

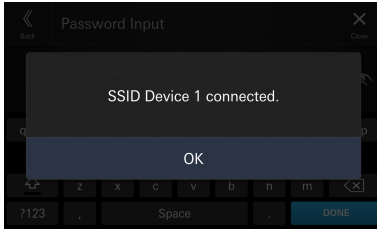

When the access point connection is complete, the Wi-Fi Access Point List screen is displayed.

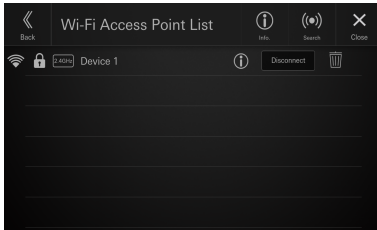

### ■ Wi-Fi Access Point List screen example

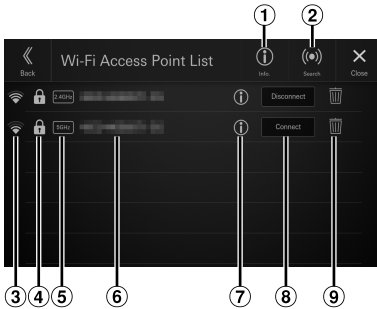

- 1 Info.  
Touch to display the MAC address and IP address of this unit.
- 2 Search  
Search for Wi-Fi access points. For details, see “Connecting to Wi-Fi Access Point” (page 16).
- 3 Signal strength of the access point
- 4 Security prompt (None/WEP/WPA/WPA2/WPA3) of the access point
- 5 Band display of the access point
- 6 SSID of the access point
- 7 Display detailed information on the access point

- 8 Connect or disconnect the selected Wi-Fi access point. For details, see “Connecting an Access Point registered in the Wi-Fi Access Point List”, “Disconnecting the Connected Access Point” (page 17).
- 9 Delete the selected Wi-Fi access point. For details, see “Deleting the Access Point from the list” (page 17).

### Connecting an Access Point registered in the Wi-Fi Access Point List

Select a Wi-Fi access point from a registered list.

### **Touch [Connect] of the access point you want to connect from the Wi-Fi Access Point List.**

Wi-Fi connection will start.

### Disconnecting the Connected Access Point

### **Touch [Disconnect] of the access point you want to disconnect from the Wi-Fi Access Point List.**

The access point is disconnected.

### Deleting the Access Point from the list

You can delete the information of a previously connected access point.

### **1 Touch [ ] (Delete) of the access point to delete from the Wi-Fi Access Point List.**

### **2 Touch [OK].**

- Touching [Cancel] will cancel the setting.

## Changing the Wi-Fi password of the unit

You can randomly change the Wi-Fi password (PSK) of the unit.

- Available only when “Wi-Fi Mode” setting is [Phone Link Mode] (page 16).

### **Setting item:**

PSK for Phone Link

### **Touch [ ] of “PSK for Phone Link”.**

The Wi-Fi password (PSK) is changed.

- This password is generated on this product. You cannot create a new password.



## Bluetooth Setup

[**Bluetooth**] is selected on the Device Setup menu screen.

### Setting the Bluetooth

Set to [**On**] when connecting the unit to the Bluetooth compatible device.

**Setting item:**  
Bluetooth

**Touch** [  ] (**Off**) or [  ] (**On**) of “**Bluetooth**”.

### Setting the Auto Connection

You can connect the last connected device automatically.

**Setting item:**  
Auto Connection

**Touch** [  ] (**Off**) or [  ] (**On**) of “**Auto Connection**”.

### Setting the PIN Code

You can set the PIN code for connecting with a Bluetooth compatible device.

**Setting item:**  
Bluetooth PIN Code

#### 1 Touch [Bluetooth PIN Code].

A numeric keypad screen is displayed.

#### 2 Touch [Delete All].

The displayed PIN code is cleared, then you can enter the new PIN code.

#### 3 Enter a 4-digit passcode, and then touch [OK].

- The initial number is 0000.
- Touch [  ] to delete an entered number.
- Touch [**Delete All**] to delete all entered numbers.

## Displaying Device Information

You can display the Bluetooth or Wi-Fi device name and device address of this unit.

**Setting item:**  
Device Info.

## Function Setup

[**Function**] is selected on the Settings menu screen.

### Function Setup Menu screen

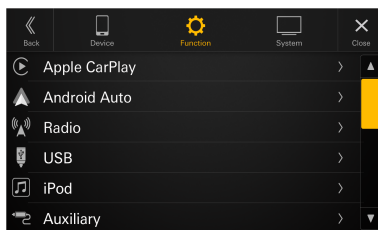

#### Setting items\*:

- Apple CarPlay (page 18)
- Android Auto (page 19)
- Radio (page 20)
- USB (page 21)
- iPod (page 22)
- Auxiliary (page 22)
- HDMI (page 23)
- Phone (page 23)
- Bluetooth Audio (page 24)
- CAN I/F BOX (page 24)
- Camera (page 25)
- TIDAL (page 27)
- Navigation (page 27)

\* Dash Cam is displayed in the setting item, but this unit does not support it.

## Apple CarPlay Setup

[**Apple CarPlay**] is selected on the Function Setup Menu screen.

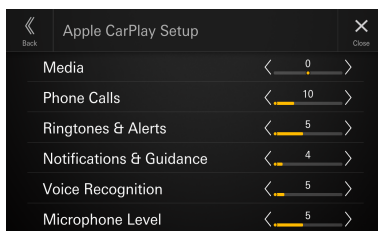

### Adjusting the Media Level

**Setting item:**  
Media

**Setting level:**  
-14 to +14 (Initial setting: 0)

**Touch** [  ] or [  ] of “**Media**” to set the media volume level for CarPlay playback.

## Adjusting the Phone Calls Volume

**Setting item:**

Phone Calls

**Setting level:**

1 to 35 (Initial setting: 5)

Touch [ < ] or [ > ] of "Phone Calls" to set the calls volume level.

## Adjusting the Ringtones and Alerts Level

**Setting item:**

Ringtones & Alerts

**Setting level:**

1 to 11 (Initial setting: 5)

Touch [ < ] or [ > ] of "Ringtones & Alerts" to set the volume level for Ringtones and Alerts.

## Adjusting the Notifications and Guidance Level

**Setting item:**

Notifications & Guidance

**Setting level:**

1 to 35 (Initial setting: 10)

Touch [ < ] or [ > ] of "Notifications & Guidance" to set the volume level for Notifications and Guidance.

## Adjusting the Voice Recognition Level

**Setting item:**

Voice Recognition

**Setting level:**

1 to 35 (Initial setting: 10)

Touch [ < ] or [ > ] of "Voice Recognition" to set the volume level for voice recognition.

## Adjusting the Microphone Level

**Setting item:**

Microphone Level

**Setting level:**

1 to 11 (Initial setting: 5)

Touch [ < ] or [ > ] of "Microphone Level" to set the microphone volume level.

## Android Auto Setup

[Android Auto] is selected on the Function Setup Menu screen.

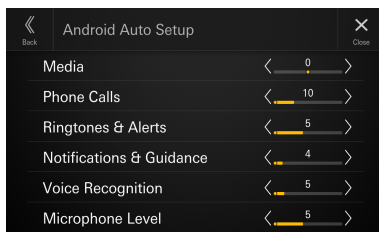

## Adjusting the Media Level

**Setting item:**

Media

**Setting level:**

-14 to +14 (Initial setting: 0)

Touch [ < ] or [ > ] of "Media" to set the media volume level for Android Auto playback.

## Adjusting the Phone Calls Volume

**Setting item:**

Phone Calls

**Setting level:**

1 to 35 (Initial setting: 5)

Touch [ < ] or [ > ] of "Phone Calls" to set the calls volume level.

## Adjusting the Ringtones and Alerts Level

**Setting item:**

Ringtones & Alerts

**Setting level:**

1 to 11 (Initial setting: 5)

Touch [ < ] or [ > ] of "Ringtones & Alerts" to set the volume level for Ringtones and Alerts.

## Adjusting the Notifications and Guidance Level

**Setting item:**  
Notifications & Guidance

**Setting level:**  
1 to 35 (Initial setting: 10)

**Touch [ < ] or [ > ] of “Notifications & Guidance” to set the volume level for Notifications and Guidance.**

## Adjusting the Voice Recognition Level

**Setting item:**  
Voice Recognition

**Setting level:**  
1 to 35 (Initial setting: 10)

**Touch [ < ] or [ > ] of “Voice Recognition” to set the volume level for voice recognition.**

## Adjusting the Microphone Level

**Setting item:**  
Microphone Level

**Setting level:**  
1 to 11 (Initial setting: 5)

**Touch [ < ] or [ > ] of “Microphone Level” to set the microphone volume level.**

## Radio Setup

[Radio] is selected on the Function Setup Menu screen.

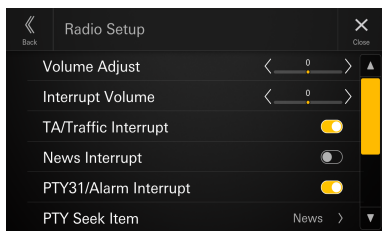

## Adjusting the Radio Volume

**Setting item:**  
Volume Adjust

**Setting level:**  
-14 to +14 (Initial setting: 0)

**Touch [ < ] or [ > ] of “Volume Adjust” to set the radio volume level.**

## Adjusting the Interrupt Volume

**Setting item:**  
Interrupt Volume

**Setting level:**  
-14 to +14 (Initial setting: 0)

**Touch [ < ] or [ > ] of “Interrupt Volume” to set the volume level for interruption broadcast.**

## Setting the TA/Traffic Interrupt

Set TA (Traffic Announcement) and Traffic Information interruption on or off.

**Setting item:**  
TA/Traffic Interrupt

**Touch [  ] (Off) or [  ] (On) of “TA/Traffic Interrupt”.**

## Setting the News Interrupt

Set News interruption on or off.

**Setting item:**  
News Interrupt

**Touch [  ] (Off) or [  ] (On) of “News Interrupt”.**

## Setting the PTY31/Alarm Interrupt

Set Emergency Broadcast (PTY31 and Alarm) interruption on or off.

**Setting item:**  
PTY31/Alarm Interrupt

**Touch [  ] (Off) or [  ] (On) of “PTY31/Alarm Interrupt”.**

## Setting the PTY Seek Item

Set the programme item received by PTY Seek.

**Setting item:**  
PTY Seek Item

**Setting contents:**



News (Initial setting) / Current Affairs / Information / Sport / Education / Drama / Culture / Science / Varied / Pop Music / Rock Music / Easy Listening / Light classical / Serious Classical / Other Music / Weather / Finance/Business / Children's / Social Affairs / Religion / Phone In / Travel / Leisure / Jazz Music / Country Music / National Music / Oldies Music / Folk Music / Documentary

## Setting the RDS Regional Mode

When Off is selected, the unit automatically keeps receiving the local RDS station.

### Setting item:

RDS Regional Mode

Touch [  ] (Off) or [  ] (On) of "RDS Regional Mode".

## PI SEEK Setting

### Setting item:

RDS PI Seek



Touch [  ] (Off) or [  ] (On) of "RDS PI Seek".

## Turning AF (Alternative Frequencies) On or Off

The RDS (Radio Data System) is a radio information system using the 57 kHz subcarrier of regular FM broadcasts. The RDS allows you to receive a variety of information such as traffic information, station names, and to automatically re-tune to a stronger transmitter that is broadcasting the same programme.

### Setting item:

RDS Alternative Frequency



Touch [  ] (Off) or [  ] (On) of "RDS Alternative Frequency".

## Setting the DAB Antenna ON/OFF

You can choose whether to supply power to DAB Antenna Connector by this setting. Confirm the type of DAB Antenna (sold separately) before installing the DAB antenna. If an active antenna that needs power supply from this unit is used, set DAB Antenna Power to On; if a passive antenna that does not need power supply from this unit is used, make sure to set DAB Antenna Power to Off, otherwise, a malfunction may occur.

### Setting item:

DAB Antenna Power

Touch [  ] (Off) or [  ] (On) of "DAB Antenna Power".

## USB Setup

[USB] is selected on the Function Setup Menu screen.

- The value set here applies to USB1 and USB2.

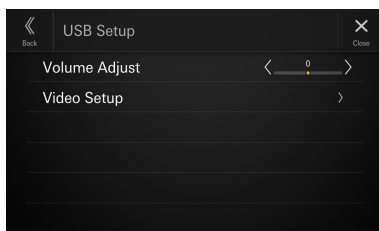

## Adjusting the USB Volume

### Setting item:

Volume Adjust

### Setting level:

-14 to +14 (Initial setting: 0)

Touch [ < ] or [ > ] of "Volume Adjust" to set the volume level for USB Audio/USB Video playback.

## Video Setup

### Setting item:

Video Setup

Touch [ < ] or [ > ] of "Brightness, Colour, Contrast" to set the picture quality.

- Available only when the current source is USB Video.

### Adjusting Brightness

#### Setting item:

Brightness

#### Setting contents:

-15 to +15 (Initial setting: 0)

### Adjusting Colour of Picture

#### Setting item:

Colour

#### Setting contents:

0 to 2 (Initial setting: 0)

### Adjusting Image Contrast

#### Setting item:

Contrast

#### Setting contents:

-15 to +15 (Initial setting: 0)

---

## iPod Setup

---

[iPod] is selected on the Function Setup Menu screen.

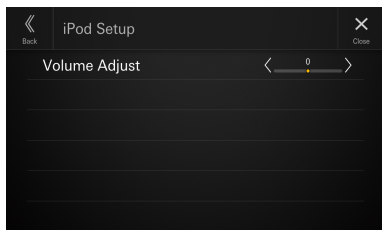

### Adjusting the iPod Volume

**Setting item:**

Volume Adjust

**Setting level:**

-14 to +14 (Initial setting: 0)

Touch [ < ] or [ > ] of “Volume Adjust” to set the volume level for iPod playback.

---

## AUX (Auxiliary) Setup

---

[Auxiliary] is selected on the Function Setup Menu screen.

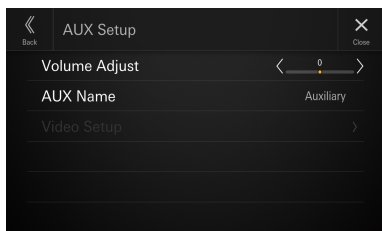

### Adjusting the AUX Volume

**Setting item:**

Volume Adjust

**Setting level:**

-14 to +14 (Initial setting: 0)

Touch [ < ] or [ > ] of “Volume Adjust” to set the volume level for AUX playback.

## Setting the Auxiliary (AUX) Name

Set the display name of an external device. This name is displayed as a source name on the HOME screen or Audio screen.

**Setting item:**

AUX Name

**Setting contents:**

Off / Auxiliary (Initial setting) / Digital TV

- *Not available when the current source is Auxiliary (or Digital TV).*

## Video Setup

**Setting item:**

Video Setup

Touch [ < ] or [ > ] of “Brightness, Colour, Contrast” to set the picture quality.

- *Available only when the current source is Auxiliary (or Digital TV).*

### Adjusting Brightness

**Setting item:**

Brightness

**Setting contents:**

-15 to +15 (Initial setting: 0)

### Adjusting Colour of Picture

**Setting item:**

Colour

**Setting contents:**

0 to 2 (Initial setting: 0)

### Adjusting Image Contrast

**Setting item:**

Contrast

**Setting contents:**

-15 to +15 (Initial setting: 0)

---

## HDMI Setup

---

[HDMI] is selected on the Function Setup Menu screen.

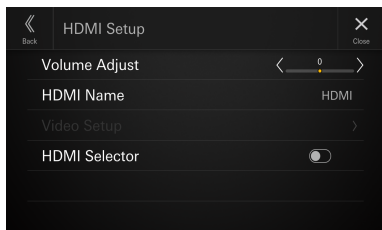

### Adjusting the HDMI Volume

**Setting item:**

Volume Adjust

**Setting level:**

-14 to +14 (Initial setting: 0)

**Touch [ < ] or [ > ] of “Volume Adjust” to set the volume level for HDMI playback.**

### Setting the HDMI Name

You can set the name of an external device connected via HDMI.

**Setting item:**

HDMI Name

**Setting contents:**

Off / HDMI (Initial setting) / Digital TV

- Not available when the current source is HDMI (or Digital TV).

### Video Setup

**Setting item:**

Video Setup

**Touch [ < ] or [ > ] of “Brightness, Colour, Contrast” to set the picture quality.**

- Available only when the current source is HDMI (or Digital TV).

### Adjusting Brightness

**Setting item:**

Brightness

**Setting contents:**

-15 to +15 (Initial setting: 0)

### Adjusting Colour of Picture

**Setting item:**

Colour

**Setting contents:**

0 to 2 (Initial setting: 0)

### Adjusting Image Contrast

**Setting item:**

Contrast

**Setting contents:**

-15 to +15 (Initial setting: 0)

### Setting the HDMI Selector

Set to [On] when the optional HDMI Selector is connected.

**Setting item:**

HDMI Selector

**Touch [  ] (Off) or [  ] (On) of “HDMI Selector”.**

---

## Phone Setup

---

[Phone] is selected on the Function Setup Menu screen.

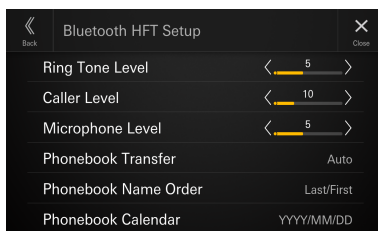

### Adjusting the Ringtone Volume

**Setting item:**

Ring Tone Level

**Setting level:**

1 to 11 (Initial setting: 5)

**Touch [ < ] or [ > ] of “Ring Tone Level” to set the Ringtones volume level.**

- Not available when Apple CarPlay or Android Auto is connected.

## Adjusting the Phone Calls Volume

**Setting item:**

Caller Level

**Setting level:**

1 to 35 (Initial setting: 5)

Touch [ < ] or [ > ] of “Caller Level” to set the calls volume level.

- Not available when Apple CarPlay or Android Auto is connected.

## Adjusting the Microphone Level

**Setting item:**

Microphone Level

**Setting level:**

1 to 11 (Initial setting: 5)

Touch [ < ] or [ > ] of “Microphone Level” to set the microphone volume level.

- Not available when Apple CarPlay or Android Auto is connected.

## Setting the Phonebook Transfer

Set whether to transfer the phonebook automatically.

**Setting item:**

Phonebook Transfer

**Setting contents:**

Auto (Initial setting) / Manual

## Setting the Phonebook Name Order

Set the order of the last name and first name displayed in the phonebook.

**Setting item:**

Phonebook Name Order

**Setting contents:**

Last/First / First/Last (Initial setting)

## Setting the Phonebook Calendar

Set the date format displayed in the phonebook.

**Setting item:**

Phonebook Calendar

**Setting contents:**

YYYY/MM/DD (Initial setting) / MM/DD/YYYY / DD/MM/YYYY

## Bluetooth Audio Setup

[Bluetooth Audio] is selected on the Function Setup Menu screen.

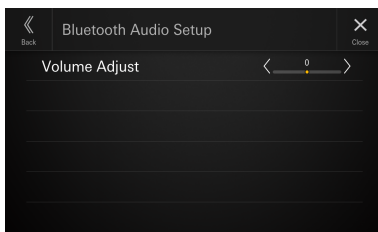

## Adjusting the Bluetooth Audio Volume

**Setting item:**

Volume Adjust

**Setting level:**

-14 to +14 (Initial setting: 0)

Touch [ < ] or [ > ] of “Volume Adjust” to set the volume level for Bluetooth Audio playback.

## CAN I/F BOX Setting

[CAN-I/F] is selected on the Function Setup Menu screen.

- Available only when the optional CAN I/F BOX is connected.

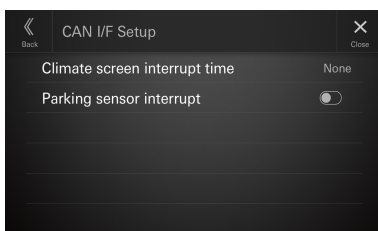

## Setting the Climate Screen Interrupt Time

You can set the time displayed in the Climate screen.

**Setting item:**

Climate screen interrupt time

**Setting contents:**

None / 5 sec (Initial setting) / 10 sec / Continuous display

None: The Climate screen is not displayed when you adjust the air conditioner, etc.

5 sec/10 sec\*: The Climate screen is displayed for 5 seconds/10 seconds, then returns to the previous screen.

Continuous display: The Climate screen is continuously displayed.



\* If you set the air conditioner, etc., while the Climate screen is displayed, the screen will continuously be displayed.

## Setting the Parking Sensor Interrupt On/Off

Set to **[On]** to display the Parking Assist screen if a vehicle detects an obstacle.

### Setting item:

Parking sensor interrupt

Touch [  ] (Off) or [  ] (On) of "Parking sensor interrupt".

## Camera Setup

[Camera] is selected on the Function Setup Menu screen.

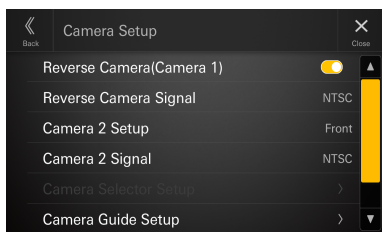

## Setting the Reverse Camera (Camera 1)

Set to **[On]** when the optional reverse camera is connected.

### Setting item:

Reverse Camera (Camera 1)

Touch [  ] (Off) or [  ] (On) of "Reverse Camera (Camera 1)".

- "Reverse Camera (Camera 1)" is not available when the Camera Setup screen is displayed using [Setup] of the Camera screen.

## Reverse Camera Signal Input Setting

When "Reverse Camera (Camera 1)" setting is **[On]**, the video input signal type can be chosen.

### Setting item:

Reverse Camera Signal

### Setting contents:

NTSC (Initial setting) / PAL

## Camera 2 Setup

Set how the second camera is used.

### Setting item:

Camera 2 Setup

### Setting contents:

Off (Initial setting) / Front / Side / Other / Camera Selector\*

- \* Select this when connecting the optional Multi Camera Selector Interface module. When connecting the optional Multi Camera Selector Interface module, you can connect up to 3 cameras as Front Camera/Rear Camera/Side Camera.

- "Camera 2 Setup" is not available when the Camera Setup screen is displayed using [Setup] of the Camera screen.

## Camera 2 Signal Input Setting

When "Camera 2 Setup" setting is not **[Off]** or **[Camera Selector]**, the video input signal type can be chosen.

### Setting item:

Camera 2 Signal

### Setting contents:

NTSC (Initial setting) / PAL

## Camera Selector Setup

Set On/Off for the camera connecting to the optional Multi Camera Selector Interface module and select the video input signal type.

### Setting item:

Camera Selector Setup

### Setting contents:

Front Camera / Rear Camera\* / Side Camera

- \* [Rear Camera] is not available when "Reverse Camera (Camera 1)" is set to **[On]**.

**1** Touch [Front Camera], [Rear Camera] or [Side Camera], and then touch [  ] (Off) or [  ] (On).

When the camera is set to **[On]**, "Camera Signal" will be available.

**2** Touch [NTSC] (Initial setting) or [PAL].

- "Camera Selector Setup" is not available when the Camera Setup screen is displayed using [Setup] of the Camera screen.

## Camera Guide Setup

You can adjust the camera guide position.

### Setting item:

Camera Guide Setup

#### 1 Touch [Camera Guide Setup] on the Camera Setup menu screen.

The camera guide adjustment screen is displayed.

#### 2 Touch [Camera], and then touch a camera, [Rear], [Front] or [Side], to adjust.

- The guide line of the Other Camera cannot be adjusted.

#### ■ Rear Camera screen example

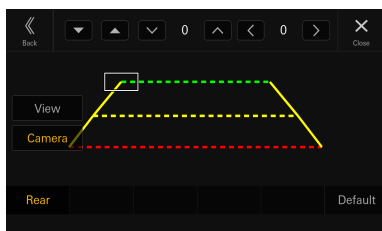

#### ■ Front Camera screen example

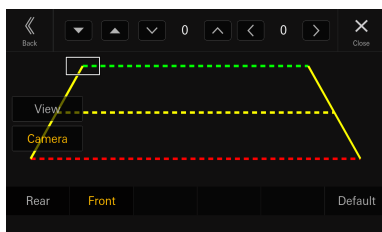

#### ■ Side Camera screen example

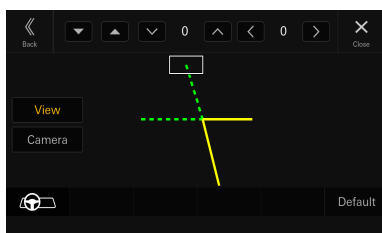

- When adjusting the side camera, touch [View], and then [Left steering] (Left steering) or [Right steering] (Right steering) to make the guide line adjustment that matches the position of the steering wheel in your vehicle.

#### 3 Select a guide to adjust by touching [▼][▲].

#### 4 Touch [▼], [▲], [←] or [→] to adjust the position of the guide.

#### 5 Touch [Back] or [Close] to complete the adjustment.

- The setting can be returned to the default setting by touching [Default].

### Hitch Guideline Adjustment

Adjustment can be made only by Rear Camera.

#### 1 Touch [View], and then touch [Hitch].

The Hitch adjustment screen is displayed.

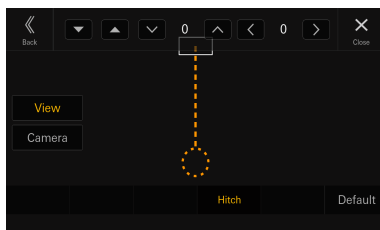

#### 2 touch [▼][▲] to select the guide to adjust.

#### 3 Touch [▼], [▲], [←] or [→] to adjust the position of the guide.

#### 4 Touch [Back] or [Close] to complete the adjustment.

- The setting can be returned to the default setting by touching [Default].

## Video Setup

### Setting item:

Video Setup

Touch [←] or [→] of "Brightness, Colour, Contrast" to set the picture quality

### Adjusting Brightness

#### Setting item:

Brightness

#### Setting contents:

-15 to +15 (Initial setting: 0)

### Adjusting Colour of Picture

#### Setting item:

Colour

#### Setting contents:

0 to 2 (Initial setting: 0)

### Adjusting Image Contrast

#### Setting item:

Contrast

#### Setting contents:



-15 to +15 (Initial setting: 0)

## Setting the Mute while Reversing

The audio volume can be muted when the shift gear lever is set to the reverse (R) position.

### Setting item:

Mute while Reversing

Touch [  ] (Off) or [  ] (On) of “Mute while Reversing”.

## TIDAL Setup

[TIDAL] is selected on the Function Setup Menu screen.

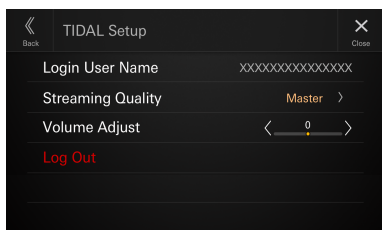

## Confirm Login User Name

### Setting item:

Login User Name

- Login User Name is blank if you are not logged in to TIDAL.

## Setting the Streaming Quality

You can set the desired sound quality. Data traffic can be reduced by lowering the sound quality.

### Setting item:

Streaming Quality

### Setting contents:

Normal / High / HiFi / Master (Initial setting)

**Normal:** This setting can reduce data usage and is an effective option when the communication speed is slow.

**High:** This setting offers the best balance between data usage and sound quality.

**HiFi:** This setting delivers sound quality equivalent to that of CDs.

**Master:** This setting reproduces mastering studio sound and delivers it as the artist intended.

## 1 Touch to select [Streaming Quality].

The Streaming Quality screen is displayed.

## 2 Select the sound quality on the Streaming Quality screen, and touch [OK].

- Streaming Quality is blank if you are not logged in to TIDAL.

## Adjusting the TIDAL Volume

### Setting item:

Volume Adjust

### Setting level:

-14 to +14 (Initial setting: 0)

Touch [ < ] or [ > ] of “Volume Adjust” to set the volume level for TIDAL playback.

## Logging out of TIDAL

### Setting item:

Log Out

## 1 Touch [Log Out].

The confirmation screen is displayed.

## 2 After the confirmation message appears, touch [OK].

- After logging out, the TIDAL Setup menu screen reappears, the logout setting item is invalid and grayed out.

## Navigation Setup

[Navigation] is selected on the Function Setup Menu screen.

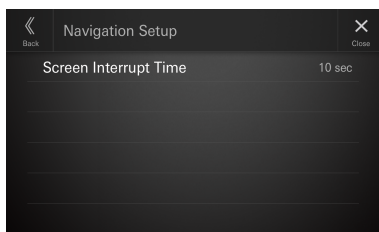

## Navigation interrupt setting

When the optional Navigation Stick (KTX-NS01AU) is connected, set the time to cancel the interrupt of the guidance screen (enlarged intersection map display, etc.) from the navigation.

### Setting item:

Screen Interrupt Time

### Setting contents:

5 sec / 10 sec (Initial setting) / 15 sec / Continuous display

5 sec/10 sec/15 sec: The guidance screen is displayed for 5 seconds/10 seconds/15 seconds, then returns to the previous screen.

Continuous display: The guidance screen is continuously displayed.

- This cannot be set if the optional Navigation Stick (KTX-NS01AU) is not connected.

- The interrupt cancellation of the guidance screen starts counting the set time after the end of the voice guidance.
- For navigation operations, refer to the Owner's Manual of the Navigation Stick (KTX-NS01AU).

## System Setup

[System] is selected on the Settings menu screen.

### ■ System Setup Menu screen

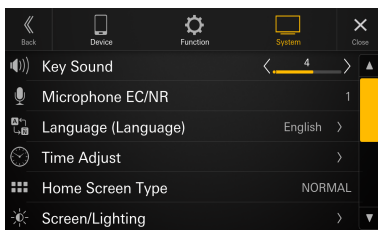

#### Setting Items:

- Key Sound (page 28)
- Microphone EC/NR (page 28)
- Language (Language) (page 29)
- Time Adjust (page 29)
- Home Screen Type (page 29)
- Screen/Lighting (page 29)
- Screen Colour (page 30)
- Source Priority Setup (page 30)
- Security Code (page 30)
- Vehicle Types for Phone Link (page 30)
- Advanced Dynamic (page 31)
- Installation Status (page 31)
- About (page 31)

## Adjusting the Key Sound

[Key Sound] is selected on the System Setup Menu screen. You can change the volume of the sound heard when a button is touched.

#### Setting item:

Key Sound

#### Setting contents:

0 to 7 (Initial setting: 4)

## Setting the Microphone Effect

[Microphone EC/NR] is selected on the System Setup Menu screen.

Set this item when using a hands-free call or calling on Apple CarPlay/Android Auto.

You can adjust the level of the Microphone Effect according to the space inside the vehicle.

#### Setting item:

Microphone EC/NR

#### Setting contents:

1 / 2 (Initial setting) / 3

- 1: Small space inside the vehicle
- 2: Middle space inside the vehicle
- 3: Large space inside the vehicle

- This setting does not apply to Voice Recognition function.

---

## Language Setup

---

[**Language (Language)**] is selected on the System Setup Menu screen.

The Setup menu, feedback information, etc. for this unit can be changed to appear in the selected language.

**Setting item:**

Language\*1 (Language\*2)

**Setting contents:**

English (Initial setting) / Deutsch / Français / Español / Português / Italiano / Nederlands / Suomi / Norsk / Svenska / Dansk / русский язык / Slovenčina / Polski / Český / Magyar / Ελληνικά / עברית / Türkçe / العربية / 日本語 / עברית / Bahasa Indonesia

• *The currently selected language is displayed.*

\*1 Display in the currently selected language.

\*2 Always display in English.

---

## Adjusting the Clock

---

[**Time Adjust**] is selected on the System Setup Menu screen.

**Setting item:**

Time Adjust

### Setting the Time Format

The time format of the clock display can be set to the 12-hour or 24-hour display according to your preference.

**Setting item:**

Time Format

**Setting contents:**

12h / 24h (Initial setting)

### Setting the Time Zone

The time zone can be set according to your region.

**Setting item:**

Time Zone

**Initial setting:**

UTC

### Setting the Daylight Savings Time

To set the daylight saving time (Summer Time mode), set "Daylight Savings Time" to [On].

**Setting item:**

Daylight Savings Time

Touch [  ] (Off) or [  ] (On) of "Daylight Savings Time".

---

## Setting the Home Screen Type

---

[**Home Screen Type**] is selected on the System Setup Menu screen.

The Home screen can be changed to the Enhanced Text mode. For details, see "About the HOME Screen" (page 12).

**Setting item:**

Home Screen Type

**Setting contents:**

NORMAL (Initial setting) / Enhanced Text

---

## Screen/Lighting Setup

---

[**Screen/Lighting**] is selected on the System Setup Menu screen.

### Setting the Brightness of the Backlighting (Dimmer)

Backlighting is provided by LEDs light built into the liquid crystal panel. The illumination control adjusts the brightness of the backlighting based on the car ambient lighting for easier viewing.

**Setting item:**

Dimmer

**Setting contents:**

Auto (Initial setting) / On / Off

Auto: Changes the brightness of the display and button lighting according to the brightness of the car interior.

On: The brightness set with [Key Illumination Level] (page 29) and [Screen Dimmer Level] (page 29) is applied regardless of the brightness of the car interior.

Off: Keeps the display and button lighting bright, regardless of the brightness of the car interior.

### Adjusting the Dimmer of Button Lighting at Night

You can adjust the brightness of the button lighting at night with the dimmer.

**Setting item:**

Key Illumination Level

**Setting level:**

-2 to +2 (Initial setting: 0)

• *This setting is only available when "Dimmer" is set to [On] or [Auto].*

### Adjusting the Minimum Level of Backlight

You can adjust the brightness of the backlight. This function could be used, for instance, to change the screen brightness while traveling at night.

**Setting item:**

Screen Dimmer Level

**Setting contents:**

-15 to +15 (Initial setting: 0)

• *This setting is only available when "Dimmer" is set to [On] or [Auto].*

---

## Switching the Display Colour

---

[Screen Colour] is selected on the System Setup Menu screen.

You can choose from 8 different display colours.

**Setting item:**

Screen Colour

**Setting contents:**

Sporty Blue (Initial setting) / Sporty Red / Sporty Green / Sporty White / Simple White / Simple Light Blue / Simple Amber / Simple Blue

---

## Editing HOME screen

---

[Source Priority Setup] is selected on the System Setup Menu screen.

In the Widgets editing screen, you can change the audio source order.

**Setting item:**

Source Priority Setup

**Touch [ ▼ ] [ ▲ ] of the source name to change the order.**

---

## Setting Security Code

---

[Security Code] is selected on the System Setup Menu screen.

You can set the system to be unusable without entering a password.

When you turn this setting to "On" and set a password, password input is required when the system is connected to a battery and turned on for the first time.

**Setting item:**

Security Code

**Setting contents:**

Off (Initial setting) / On

---

## Setting the password

**1 Touch [  ] (Off) of "Security Code".**

**2 After the confirmation message appears, touch [OK].**

The password setting screen is displayed.

**3 Enter a password, then touch [OK].**

- Enter the 6-digit number.
- Input numbers are displayed as "\*\*\*".
- Touch [  ] to delete an entered number.
- Touch [Delete All] to delete all entered numbers.

**4 Enter the same password again, then touch [OK].**

The password is set and the system returns to the System Setup Menu screen, then the Security Code is set to [On].

- *If you forget a registered password, you can not use this unit. In this case, service will be required.*

---

## Clearing the password

**1 Touch [  ] (On) of "Security Code".**

The password setting screen is displayed.

**2 Enter the password you have set, then touch [OK].**

The password is cleared and the system returns to the System Setup Menu screen, then the Security Code is set to [Off].

- Input numbers are displayed as "\*\*\*".

---

## Vehicle Type Setup

---

[Vehicle Types for Phone Link] is selected on the System Setup Menu screen.

Apple CarPlay and Android Auto require information about the vehicle to use all functions in the best possible way.

**Setting item:**

Vehicle Types for Phone Link

---

## Steering wheel Setting

Set this item when Apple CarPlay is used/Android smartphone which installed Android Auto App is connected.

This setting influences Apple CarPlay/Android Auto mode.

**Setting item:**

Steering wheel

**Setting contents:**

Left (Initial setting) / Right

---

## Fuel Type Setting

Set the Fuel type of your car.

**Setting item:**

Fuel Type

**Setting contents:**

Unknown / Unleaded gasoline (Initial setting) / Leaded gasoline / Diesel #1 / Diesel #2 / Biodiesel / 85% ethanol/gasoline blend / Liquefied petroleum gas / Compressed natural gas / Liquefied natural gas / Electric / Hydrogen fuel cell / Other

---

## EV Connector Type Setting

When [Electric] is selected for "Fuel Type Setting" (page 30), set EV Connector Type.

**Setting item:**

EV Connector Type

**Setting contents:**

Unknown (Initial setting) / J1772 / Mennekes / Chademo / Combo\_1 / Combo\_2 / Tesla roadster / Tesla HPWC / Tesla Supercharger / GBT / Other

## Audio Leveling

[**Advanced Dynamic**] is selected on the System Setup Menu screen.

This function raises (On) or lowers (Off) the output level up to 14dB.

### Setting item:

Advanced Dynamic

Touch [  ] (Off) or [  ] (On) of "Advanced Dynamic".

- Sound is output from the Speaker Output and PRE OUT connectors regardless of this setting.
- This setting applies to the Speaker Output and PRE OUTs Front, Rear and Subwoofer.
- This setting does not apply to the volume level for the Hands-free Phone.

## Installation Setup

[**Installation Status**] is selected on the System Setup Menu screen.

Vehicle Setup enables you to check the installation status of Camera 1, Camera 2, CAN Box, Dash Cam\*, GPS Antenna, GPS Information, Park, Vehicle Speed, Reverse, Battery Voltage.

\* Dash Cam is displayed in the Installation Setup, but this unit does not support it.

### Setting item:

Installation Status

The Installation check screen is displayed.

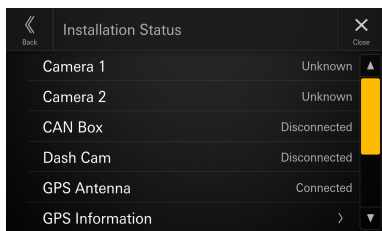

- Depending on your vehicle, some installation status may not be checked via this function.

## About iLX-507A/iLX-F509A/iLX-F511A

[**About**] is selected on the System Setup Menu screen.

By using [**About**], the Serial Number and Model name can be checked, the Firmware Version can be updated, and various settings can be initialised.

## Displaying the Product Information

You can view the version information of this product. Make note of this information and refer to it whenever you contact Alpine Tech Support or an Alpine-authorized dealer.

### Setting contents:

Serial Number / Model Name

## Updating Firmware Version

Download the software from the Alpine website and update the product using the USB flash drive.

### Setting item:

Firmware Version

**1 Plug the USB flash drive with the update file stored into the USB 1 port of the unit.**

**2 Touch [Update] of "Firmware Version".**

**3 After the confirmation message appears, touch [OK].**

Software Update screen is displayed, after finish checking the update file.

**4 After Software Update screen is displayed, touch [Update].**

System will restart automatically when the update is complete.

- Do not turn on/off the power, change the ignition key position, until system restart is completed.

## Dedicated Tuning According to Your Car (Car by Car Update)

For some car models, you can perform settings by downloading the data of the car model from the Alpine website. Install the data to the unit by using the USB flash drive.

- Introduction image, sound dedicated to the car model, camera connection setting and camera guide line can be set with the data of the car model.

### Setting item:

Car by Car Update

**1 Plug the USB flash drive with the update file stored into the USB 1 port of the unit.**

**2 Touch [Update] of "Car by Car Update".**

### 3 After the confirmation message appears, touch [OK].

- Do not turn on/off the power, change the ignition key position, until system restart is completed.

## Displaying Software License

### Setting item:

Open-Source Software License

## Initialising the Sound Settings

You can restore the EQ Setting\*/X-OVER\*/Time Correction\*/Media Xpander (MX)/bass engine/Subwoofer to factory settings.

### Setting item:

Default Sound Settings

### 1 Touch [Set] of "Default Sound Settings".

### 2 After the confirmation message appears, touch [OK].

The system starts initialisation.

- \* The setting values that are stored in Preset 1 to Preset 3 cannot be initialised.

## Initialising the System

You can initialise all data, to restore the factory settings. Remove the USB flash drive, etc. from the system before operation.

### Setting item:

Clear All Settings

### 1 Touch [Reset] of "Clear All Settings".

### 2 After the confirmation message appears, touch [OK].

The confirmation screen appears.

### 3 Touch [OK].

The system starts initialisation.

- Do not turn on/off the power, change the ignition key position, until system restart is completed.

## Sound Setup

You can set up items related to the sound quality.

### Touch the upper central area [▼] of the Home screen.

The Sound Setup screen is displayed.



- The Sound Setup screen can also be displayed by touching [ ] (HOME) while displaying the Home screen.

### ■ Sound Setup Menu screen

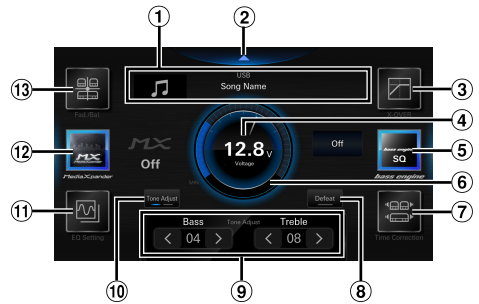

- 1 Current source information display.
- 2 Touch this to change to the Home screen.
- 3 X-OVER (page 35)
- 4 Voltage display.
- 5 bass engine (page 36)
- 6 Volume level indicator
- 7 Time Correction (page 35)
- 8 Defeat (page 37)
- 9 Tone Adjust (Bass/Treble) (page 36), Sub Woofer Level (page 36), or Navigation (Navi volume/Background Audio) (page 37)
- 10 Switch between Tone Adjust, Sub Woofer Level or Navigation mode.
- 11 EQ Setting (page 33)
- 12 Media Xpander (page 33)
- 13 Fader/Balance/Rear Speaker/Subwoofer (page 34)



## Setting the Media Xpander (MX)

[Media Xpander] is selected on the Sound Setup Menu screen.

Media Xpander (MX) makes vocals or instruments sound distinct regardless of the music source. Music sources other than the radio (AM) will be able to reproduce the music clearer even in cars with a lot of road noise.

### Setting item:

Media Xpander

### Setting contents:

OFF (Initial setting) / MX 1 / MX 2 / MX 3

## 1 Touch [Media Xpander].

The Media Xpander setting screen is displayed.

## 2 Touch [Media Xpander] to switch the level.

OFF → MX 1 → MX 2 → MX 3 → OFF

- The Media Xpander setting screen is returned to the Sound Setup Menu screen if no operation has been performed for more than 3 seconds.
- MP3/WMA/AAC/FLAC/WAV/APE can have its own MX setting.
- When the Defeat setting is [On], you cannot perform the set up.
- Not available when "bass engine" is set.
- The MX setting can be performed only when a source is currently selected.

## Equalizer Settings

[EQ Setting] is selected on the Sound Setup Menu screen. EQ Setting has 3 modes, "Advanced EQ", "Basic EQ" and "Preset EQ".

- When the Defeat setting is [On], you cannot perform the set up.
- Not available when "bass engine" is set.

## Adjusting the Parametric Equalizer Curve (Advanced EQ/Basic EQ)

You can modify the Equalizer settings to create a response more appealing to your personal taste.

This unit has "Advanced EQ" which can set 4 types of speakers, and "Basic EQ" which can set 2 types of speakers.

### ■ Advanced EQ

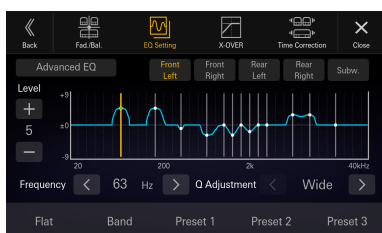

### ■ Basic EQ

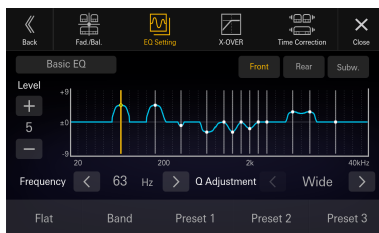

## 1 Touch [EQ Setting].

## 2 Touch [Advanced EQ] or [Basic EQ] to select Equalizer mode.

## 3 Select a speaker to adjust.

Advanced EQ: Front Left / Front Right / Rear Left / Rear Right / Subw.

Basic EQ: Front / Rear / Subw.

## 4 Touch [Band] to select the band to be adjusted.

Band1 → Band2 → ... → Band12 → Band13 → Band1

- You can select a band directly by touching the screen.

## 5 Touch [ < ] or [ > ] of "Frequency" to adjust the frequency of the selected band.

### Adjustable frequency bands:

20 Hz to 40 kHz (in 1/3 octave steps)

Band1:	20 Hz~100 Hz (63 Hz)
Band2:	63 Hz~315 Hz (125 Hz)
Band3:	100 Hz~500 Hz (200 Hz)
Band4:	160 Hz~800 Hz (315 Hz)
Band5:	250 Hz~1.25 kHz (500 Hz)
Band6:	315 Hz~1.6 kHz (630 Hz)
Band7:	500 Hz~2.5 kHz (1 kHz)
Band8:	1 kHz~5 kHz (2 kHz)
Band9:	1.6 kHz~8 kHz (3.15 kHz)
Band10:	2.5 kHz~12.5 kHz (5 kHz)
Band11:	4 kHz~20 kHz (8 kHz)
Band12:	6.3 kHz~31.5 kHz (12.5 kHz)
Band13:	10 kHz~40 kHz (20 kHz)

## 6 Touch [ - ] or [ + ] of "Level" to adjust the level of selected band.

### Setting contents:

-9 to +9 (Initial setting: 0)

## 7 Touch [ < ] or [ > ] of “Q Adjustment” to select the bandwidth.

### Setting contents:

Wide (Initial setting) / Medium / Narrow

## 8 Repeat steps 3 to 7, and adjust all speakers.

## 9 To store the adjusted setting value, touch and hold [Preset 1], [Preset 2], or [Preset 3] for at least 2 seconds.

- Band2 and Band11 are the same as the Bass and Treble controls. For details on setting Bass and Treble, see “Adjusting Bass Level/Treble Level” (page 36).
- Settings exceeding the frequency of adjacent bands are not available.
- While adjusting the Parametric EQ, you should consider the frequency response of the connected speakers.
- When the Parametric EQ is adjusted, the Preset EQ is overridden.
- When Preset EQ is set, the linked Parametric EQ settings are also changed. We recommend storing Parametric EQ settings in a Preset in advance.
- Touch [Flat] to initialise all values.

### Calling the Parametric EQ adjusted value

Calling the pre-set Parametric EQ adjusted value.

### Touch [Preset 1], [Preset 2], or [Preset 3] on the Parametric EQ screen.

The setting stored in the Preset will be recalled.

## Equalizer Presets (Preset EQ)

10 typical equalizer settings are preset at the factory for a variety of musical source material.



### Setting item:

Preset EQ

### Setting contents:

FLAT / POP / ROCK / NEWS / JAZZ / ELECTRONIC / HIP HOP / EASY LISTENING / COUNTRY / CLASSICAL

- EQ Presets has no initial setting, there is no typical equalizer will be selected in the initial status.
- Only one type can be set to On.
- When Preset EQ is set, the linked Parametric EQ settings are also changed. We recommend storing Parametric EQ settings in a Preset in advance.

## Fader/Balance/Rear Speaker/ Subwoofer Settings

[Fad./Bal.] is selected on the Sound Setup Menu screen.

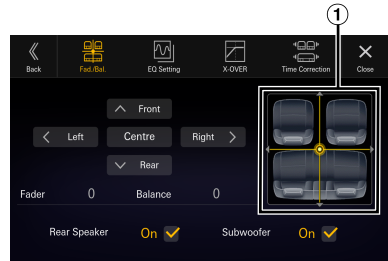

### ① Fader/Balance Image area

## Setting the Fader/Balance

Touch the desired point within the image area, or touch [ ^ ] (Front), [ v ] (Rear), [ < ] (Left) or [ > ] (Right).

### Fader:

F15 to R15

### Balance:

L15 to R15

- To reset to the initial setting (Balance: 0, Fader: 0), touch [Centre].

## Rear Speaker Setting

You can set the rear speaker output to “Off”.

### Setting item:

Rear Speaker

### Setting contents:

On (Initial setting) / Off

## Turning Subwoofer ON/OFF

If an optional subwoofer is connected to the unit, make the following setting.

### Setting item:

Subwoofer

### Setting contents:

On / Off (Initial setting)

## Time Correction Settings

[**Time Correction**] is selected on the Sound Setup Menu screen.

Before performing the following procedures, see “About Time Correction” (page 38).

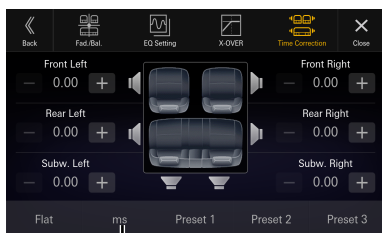

Correction mode

### Setting item:

Time Correction

**1** Touch the **Correction mode** button, and then select [**ms**], [**cm**] or [**inch**].

**2** Touch [**-**] or [**+**] for each speaker to adjust the time or distance.

0.00 msec to 20.00 msec (0.02 msec/step)

0.0 cm to 680.0 cm (0.68 cm/step)

0.0 inch to 268.0 inch (0.268 inch/step)

All speaker setting values are adjustable in the range of 20.0 ms, 680.0 cm or 268.0 inch.

**3** To store the adjusted setting value, touch and hold [**Preset 1**], [**Preset 2**], or [**Preset 3**] for at least **2 seconds**.

- Touch [**Flat**] to set all values to 0.0.
- If the Rear Speaker setting is [**Off**], the Rear Speaker setting cannot be edited (page 34).
- If the Subwoofer setting is [**Off**], the Subwoofer setting cannot be edited (page 34).

### Calling the Time Correction Value

Calling the pre-set time correction value.

Touch [**Preset 1**], [**Preset 2**], or [**Preset 3**] on the time correction screen.

The setting stored in the Preset will be recalled.

## Crossover Settings (X-OVER)

Before performing the following procedures, see “About the Crossover” (page 37).

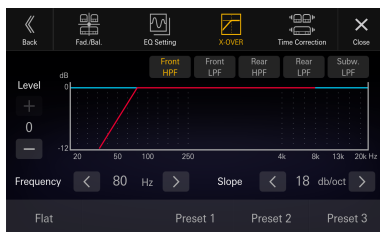

### Setting item:

X-OVER

**1** Touch [**X-OVER**].

The X-OVER setting screen is displayed.

**2** Touch [**Front HPF**], [**Front LPF**], [**Rear HPF**], [**Rear LPF**] or [**Subw. LPF**] to select a channel to adjust.

**3** Touch [**<**] or [**>**] of “Frequency,” and then select the cut-off frequency.

### Setting contents:

Front HPF:	20 / 25 / 31.5 / 40 / 50 / 63 / 80 (Initial setting) / 100 / 125 / 160 / 200 / 250 Hz
Front LPF:	4k / 5k / 6.3k / 8k (Initial setting) / 10k / 12.5k / 16k / 20k Hz
Rear HPF:	20 / 25 / 31.5 / 40 / 50 / 63 / 80 (Initial setting) / 100 / 125 / 160 / 200 / 250 Hz
Rear LPF:	4k / 5k / 6.3k / 8k (Initial setting) / 10k / 12.5k / 16k / 20k Hz
Subw.LPF:	20 / 25 / 31.5 / 40 / 50 / 63 / 80 (Initial setting) / 100 / 125 / 160 / 200 / 250 Hz

**4** Touch [**<**] or [**>**] of “Slope,” and then adjust the HPF or LPF slope.

### Setting contents:

0 (Initial setting) / 6 / 12 / 18 / 24 dB/oct.

**5** Touch [**-**] or [**+**] of “Level,” and then adjust the HPF or LPF level.

### Setting contents:

-12 to 0 dB (Initial setting: 0)

**6** Repeat steps 2 to 5 to make adjustment to the other channels.

## 7 To store the adjusted setting value, touch and hold [Preset 1], [Preset 2], or [Preset 3] for at least 2 seconds.

- Touch [Flat] to initialise all values.
- If the Rear Speaker setting is [Off], the Rear Speaker setting cannot be edited (page 34).
- If the Subwoofer setting is [Off], the Subwoofer setting cannot be edited (page 34).
- While adjusting the X-OVER you should consider the frequency response of the connected speakers.

### Calling the X-OVER adjusted value

Calling the pre-set X-OVER adjusted value.

### Touch [Preset 1], [Preset 2], or [Preset 3].

The setting stored in the Preset will be recalled.

---

## Setting the "bass engine"

---

You can set your favourite "bass engine" Type.

### Setting contents:

Type:	Off (Initial setting) / Standard / midbass / Rich / Lowbass / Punch
Level:	0 to 6

### 1 Touch [bass engine].

The "bass engine" setting screen is displayed.

### 2 Touch [bass engine] to switch the type.

Off → Standard → midbass → Rich → Lowbass → Punch → Off

### 3 Touch [–] or [+] of "BASS ENGINE Level," and then adjust the level.

- When the Defeat setting is [On], you cannot perform the bass engine function.
- The "bass engine" setting screen is returned to the Sound Setup Menu screen if no operation has been performed for more than 3 seconds.

---

## Adjusting Bass Level/Treble Level

---

### Setting item:

Bass, Treble

### Setting contents:

Bass:	-18 to 18 (Initial setting: 00)
Treble:	-18 to 18 (Initial setting: 00)

### 1 Touch [Subw.] or [Navi] until the "Tone Adjust" setting screen is displayed.

The "Tone Adjust" setting screen is displayed.

### 2 Touch [<] or [>] of the "Bass" or "Treble," to adjust the level.

- The Bass level and Treble level are reflected in the settings of Band2 and Band11 in EQ Setting. Depending on settings of Band2 and Band11 in EQ Setting, the adjustable Bass level and Treble level are changed.
- Not available when "bass engine" is set.

---

## Setting the Subwoofer

---

### Touch [Tone Adjust] or [Navi] until the "Subwoofer Level" setting screen is displayed.

The "Subwoofer Level" setting screen is displayed.

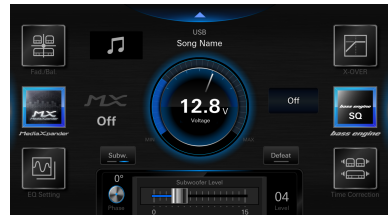

- This setting is only available when "Subwoofer" is set to [On] (page 34).

---

## Adjusting the Subwoofer Level

---

You can set the Subwoofer level when a Subwoofer is connected.

### Setting item:

Subwoofer Level

### Setting contents:

0 to 15 (Initial setting: 0)

Slide the lever left or right to adjust the level.

## Setting the Subwoofer Phase

The subwoofer output phase is toggled Subwoofer Normal (0°) or Subwoofer Reverse (180°).

**Setting item:**

Phase

**Setting contents:**

0° (Initial setting) / 180°

**Touch [Phase] to switch the subwoofer output phase.**

## Setting the Navigation

**Touch [Tone Adjust] or [Subw.] until the "Navi volume / Background Audio" setting screen is displayed.**

The "Navi volume / Background Audio" setting screen is displayed.

- This setting is only available when the optional Navigation Stick (KTX-NS01AU) is connected.

## Adjusting the Navigation Volume

You can adjust the volume of the navigation interrupt voice guidance.

**Setting item:**

Navi volume

**Setting contents:**

1 to 35 (Initial setting: 10)

**Touch [ < ] or [ > ] of "Navi volume" to set the volume level.**

## Adjusting the Background Audio Volume

You can adjust the media volume when the navigation interrupt voice guidance is played.

**Setting item:**

Background Audio

**Setting contents:**

0 to 15 (Initial setting: 5)

**Touch [ < ] or [ > ] of "Background Audio" to set the volume level.**

## Defeat Setting

If Defeat is [On], Media Xpander, EQ Setting and "bass engine" functions are turned Off. This disables any settings made for these functions.

**Setting item:**

Defeat

**Touch [Defeat].**

The indicator lights up when Defeat is set to On.

## About the Crossover

**Crossover (X-Over):**

This unit is equipped with an active crossover. The crossover limits the frequencies delivered to the outputs. Each channel is controlled independently. Thus, each speaker pair can be driven by the frequencies for which they have been optimally designed.

The crossover adjusts the HPF (high pass filter) or LPF (low pass filter) of each band, and also the slope (how fast the filter rolls off the highs or lows).

Adjustments should be made according to the reproduction characteristics of the speakers. Depending on the speakers, a passive network may not be necessary. If you are unsure about this point, please consult your authorized Alpine dealer.

	Cut-off frequency (1/3 octave steps)		Slope		Level
	HPF	LPF	HPF	LPF	
<b>Subwoofer (LPF)</b>	----	20 Hz - 250 Hz	----	0, 6, 12, 18, 24 dB/oct.	-12 to 0 dB
<b>Rear speaker (HPF)</b>	20 Hz - 250 Hz	----	0, 6, 12, 18, 24 dB/oct.	----	-12 to 0 dB
<b>Front speaker (HPF)</b>	20 Hz - 250 Hz	----	0, 6, 12, 18, 24 dB/oct.	----	-12 to 0 dB

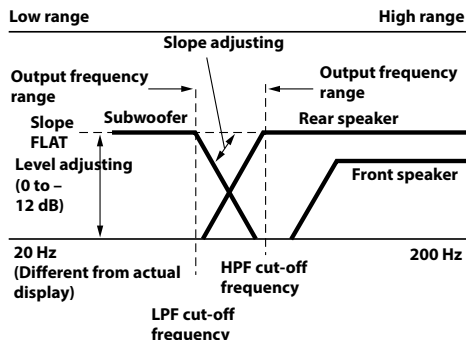

- HPF (high pass filter): Cuts the lower frequencies and allows the higher frequencies to pass.

- *LPF (low pass filter): Cuts the higher frequencies and allows the lower frequencies to pass.*
- *Slope: The level change (in dB) for a frequency change of one octave.*
- *The higher the slope value, the steeper the slope becomes.*
- *Adjust the slope to FLAT to bypass the HP or LP filters.*
- *Do not use a tweeter without the HPF on or set to a low frequency, as it may cause damage to the speaker due to the low frequency content.*
- *Adjustment should be made according to the recommended crossover frequency of the connected speakers. Determine the recommended crossover frequency of the speakers. Adjusting to a frequency range outside that recommended may cause damage to the speakers.*

*For the recommended crossover frequencies of Alpine speakers, refer to the respective Owner's Manual.*

*We are not responsible for damage or malfunction of speakers caused by using the crossover outside the recommended value*

## About Time Correction

The distance between the listener and the speakers in a car vary widely due to the complex speaker placement. This difference in the distances from the speakers to the listener creates a shift in the sounds image and frequency characteristics. This is caused by the time delay between the sound reaching the listener's right versus the left ear. To correct this, this unit is able to delay the audio signal to the speakers closest to the listener. This effectively creates a perception of increased distance for those speakers. The listener can be placed at an equal distance between the left and right speakers for optimum staging. The adjustment will be made for each speaker in 0.02 ms steps.

### Example 1. Listening Position: Front Left Seat

Adjust the time correction level of the front left speaker to a high value and the rear right to zero or a low value.

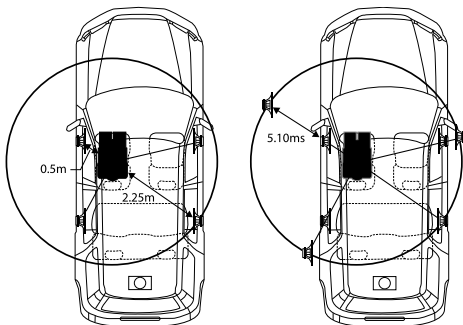

The sound is not balanced because the distance between the listening position and the various speakers is different. The difference in distance between the front left speaker and the rear right speaker is 1.75 m (68-7/8").

Here we calculate the time correction value for the front left speaker in the diagram on the above.

Conditions:

Farthest Speaker – listening position : 2.25 m (88-9/16")

Front left speaker – listening position : 0.5 m (19-11/16")

Calculation:  $L = 2.25 \text{ m} - 0.5 \text{ m} = 1.75 \text{ m} (68-7/8")$

Time correction =  $1.75 \div 343^* \times 1,000 = 5.10 \text{ (ms)}$

\* Speed of sound: 343 m/s (765 mph) at 20°C

In other words, giving the front left speaker a time correction value of 5.1 ms makes it seem as if its distance from the listener is the same as the distance to the farthest speaker.

Time correction eliminates the differences in the time required for the sound to reach the listening position. The time of the front left speaker is corrected by 5.1 ms so that its sound reaches the listening position at the same time as the sound of other speakers.

### Example 2. Listening Position: All Seats

Adjust the time correction level of each speaker to almost the same level.

- 1 Sit in the listening position (driver's seat, etc.) and measure the distance (in meters) between your head and the various speakers.**
- 2 Calculate the difference between the distance correction value to the farthest speaker and the other speakers.**

$L = (\text{distance to farthest speaker}) - (\text{distance to other speakers})$

These values are the time correction values for the different speakers. Setting these values to make each sound reach the listening position at the same time as the sound of other speakers.

# Apple CarPlay (Optional)

Apple CarPlay is a smarter, safer way to use your iPhone in the car. Apple CarPlay takes the things you want to do with your iPhone while driving and puts them right on the unit. You can get directions, make calls, send and receive messages, and listen to music, all in a way that allows you to stay focused on the road.

## Access to Apple CarPlay

To use Apple CarPlay, set the Siri setting of your iPhone to ON.

Beside using this function, plug in your iPhone using a Lightning-USB cable (supplied with iPhone) to the unit, or make a wireless connection. For wireless connection, see "Pairing the Bluetooth® Device"(page 15) and "Setting the Wi-Fi Mode (page 16) .

### 1 Press the (HOME) button.

The HOME screen is displayed.

### 2 Touch [Apple CarPlay].

The Apple CarPlay screen is displayed.

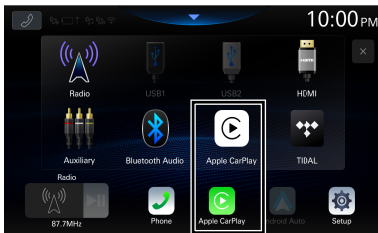

[Apple CarPlay] button

- When another iPhone is connected by USB while using CarPlay with the wireless connection, a message appears. Touch [Yes] to switch the iPhone.
- When the Android Auto compatible smartphone is connected by USB while in Apple CarPlay mode, a message appears. Only charging is available on the Android Auto compatible smartphone. When switching to Android Auto, switch from the Device List. See "Connecting the Device Registered in the Device List" (page 15).
- The App must be Apple CarPlay compatible in order to appear in the Apple CarPlay screen.
- Some functions may not be available while driving.
- The only iPhone models that can be used with this unit is iPhone 6s or later compatible with Apple CarPlay function.
- The optional Navigation Stick (KTX-NS01AU) and Apple CarPlay cannot be used at the same time.

## Using Voice Recognition function

You can use the Siri function of your iPhone. To use this function, set the Siri setting of your iPhone to ON.

- When using Apple CarPlay, the operation screen may differ from the screen design in the Owner's Manual.

### 1 Press the button.

The Voice Recognition mode screen is displayed.

### 2 Speak into the microphone supplied with this unit.

### 3 To finish the Voice Control mode, press the button.

- Depending on the iPhone, the Siri function may finish automatically.
- For adjusting the volume, see "Adjusting the Voice Recognition Level" (page 19).

# Android Auto (Optional)

## What is Android Auto

Android Auto brings your favourite smartphone apps into one place, making it easier for drivers to access their favourite navigation, media, and communication apps on the road while minimizing the distractions. Talk to Google on Android Auto™ and get things done with your voice so you can keep your eyes on the road and hands on the wheel. Easily send messages, get directions, control media and more. Just short-press or long-press the voice control button on your steering wheel.

## Activate Android Auto

Download the Android Auto App from the Google Play store before continuing.

Before using this function, plug in your smartphone using a USB cable to the unit, or make a wireless connection. For wireless connection, see "Pairing the Bluetooth® Device" (page 15) and "Setting the Wi-Fi Mode" (page 16).

- The connected smartphone with Android Auto will disconnect other phone's Bluetooth connection and pair to the unit.

### 1 Press the (HOME) button.

The HOME screen is displayed.

### 2 Touch [Android Auto].

The Android Auto screen is displayed.

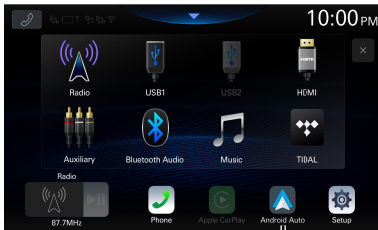

[Android Auto] button

- When another smartphone is connected by USB while using Android Auto with the wireless connection, a message appears. Touch [Yes] to switch the smartphone.
- When the iPhone is connected by USB while in Android Auto mode, a message appears.  
Only charging is available on the iPhone. When switching to Apple CarPlay, switch from the Device List. See "Connecting the Device Registered in the Device List" (page 15).
- You can make a call, use voice recognition function and Android Auto's compatible navigation app, etc.
- Only Google approved apps with necessary driver-safety measures in place can be used.
- The optional Navigation Stick (KTX-NS01AU) and Android Auto cannot be used at the same time.

## Using Voice Recognition function

You can use the Voice Recognition function of the Android Auto.

### 1 Press the button.

The Voice Recognition mode screen is displayed.

### 2 Speak into the microphone supplied with this unit.

### 3 To finish the Voice Control mode, press the button.

- Depending on the smartphone, the Voice Recognition function may finish automatically.
- For adjusting the volume, see "Adjusting the Voice Recognition Level" (page 20).



# Radio/RDS

## ■ RDS (FM1/FM2/FM3) main screen example

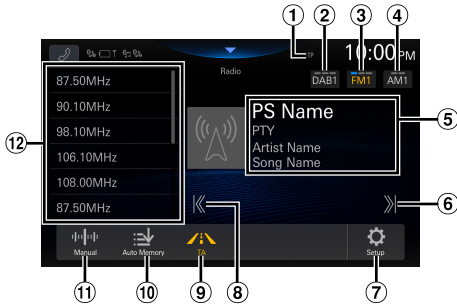

- ① TP/EON indicator
- ② Switch the DAB band.
- ③ Switch the FM band.
- ④ Switch the AM band.
- ⑤ Information display
  - For details on switching the display of the Radio text, see "Displaying Radio Text" (page 43).
- ⑥ Increases frequency  
Touch and hold to change the frequency continuously.
- ⑦ Displays the Radio Setup Menu screen (page 20).
- ⑧ Decreases frequency  
Touch and hold to change the frequency continuously.
- ⑨ Traffic Information mode On/Off
- ⑩ Memorizes stations automatically
- ⑪ Switches a Seek mode.
- ⑫ Preset List  
Displays the preset stations with a short touch.  
Touch for at least 2 seconds to memorize the current station as a preset station.

## Radio Basic Operation

### Listening to the Radio

- 1 Press the (HOME) button and select radio mode.**

The display shows the radio mode screen.

- 2 Touch [FM○] or [AM○] to select a band.**

Each touch changes the bands as follows:

FM1 → FM2 → FM3 → FM1  
AM1 → AM2 → AM1

- For [DAB○], see "DAB/DAB+" (page 43).

- 3 Touch [] repeatedly to select the tuning mode.**

The radio frequency up or down button changes depending on the tuning mode.

- |                                       |   |
|---------------------------------------|---|
| Seek mode:                            | Both strong and weak stations will be tuned in.                                       |
| Manual mode:                          | The frequency is manually tuned in steps.   |
| PTY mode:<br>(RDS FM Radio Mode only) | A station of the same programme type selected for the PTY Seek Item setting tuned in. |
| Preset mode:                          | You can directly switch preset stations.  |

- 4 Touch [] to change the radio frequency up or down respectively.**

In Manual mode, touch and hold to change the frequency continuously.

- The buttons provide the same functions above.

## Presetting Stations Manually

- 1 Tune in a desired radio station you wish to store in the preset memory by manual or automatic seek tuning.**

- 2 Touch and hold the preset button you want to store for at least 2 seconds.**

The selected station is stored.

- 3 Repeat the procedure to store up to 11 other stations onto the same band.**

To use this procedure for other bands, simply select the desired band and repeat the procedure.

A total of 60 stations can be stored in the preset memory  
(12 stations for each band; FM1, FM2, FM3, AM1 or AM2).

- If a preset memory has already been set in the preset button, it will be cleared and the new station will be memorized.

---

## Presetting Stations Automatically

---

The tuner can automatically seek and store 12 strong stations in the selected band in ascending order of frequency.

### Select the desired band then touch and hold [Auto Memory].

The tuner automatically seeks and stores 12 strong stations into the preset list in ascending order of frequency. When automatic storing has completed, the station stored in the preset 1 is selected.

- If no stations are stored, the tuner will return to the original station you were listening to before the automatic storing procedure began.
- You can cancel this process by touching [Auto Memory] while the tuner is automatically seeking stations. Canceling will return the tuner preset to the previous setting.

---

## Tuning to Preset Station

---

### After selecting the desired band, touch the desired preset button.

The preset station is received.

---

## RDS Operation

---

### Turning AF (Alternative Frequencies) On or Off

---

The RDS (Radio Data System) is a radio information system using the 57 kHz subcarrier of regular FM broadcasts. The RDS allows you to receive a variety of information such as traffic information, station names, and to automatically re-tune to a stronger transmitter that is broadcasting the same programme.

- Set RDS Alternative Frequency to [On] in "Turning AF (Alternative Frequencies) On or Off" (page 21).
- RDS mode is not be displayed for the AM band.
- When the AF ON mode is selected, the unit automatically tunes to a strong signal station in the AF list.
- Use the AF OFF mode when automatic re-tuning is not required.

#### Tips

- The RDS digital data includes the following:

PI	Programme Identification
PS	Programme Service Name
AF	List of Alternative Frequencies
TP	Traffic Programme
TA	Traffic Announcement
PTY	Programme Type
EON	Enhanced Other Networks
- Refer to page 21 about "PI SEEK Setting," "Setting the RDS Regional Mode," and "Setting the PTY31/Alarm Interrupt."

---

## Interruption Function

---

Interruption Function is enabled, when the following broadcast is received, the unit switches to the Radio source screen automatically, and will receive broadcasts.

- Alarm (Emergency Broadcast)\*1, 4
- TA(Traffic Announcement)\*2, 5
- News Announcement\*3, 4

- \*1 Set PTY31/Alarm Interrupt to [On] in "Setting the PTY31/Alarm Interrupt" (page 20).
- \*2 Set TA/Traffic Interrupt to [On] in "Setting the TA/Traffic Interrupt" (page 20).
- \*3 Set News Interrupt to [On] in "Setting the News Interrupt" (page 20).
- \*4 Not interrupted during the DAB broadcast reception.
- \*5 The Interruption Function for Traffic Announcements works with DAB broadcasts. Therefore, even if the current source is RDS, a Traffic Announcement by DAB broadcast may interrupt.
- "RDS Alarm"/"RDS T.Info"/"RDS News" is displayed in the Band display section during each respective broadcast reception.
- To cancel the Interruption function, touch [Cancel].

- Touch **[Disable]** when interrupted, to disable the Interruption function. The setting for the interruption type becomes **[Off]**. For example, the Interruption function becomes disabled and the News Interrupt setting is set to **[Off]** by touching **[Disable]** when “News” is interrupting.
- If no signal is received for more than 60 seconds, interrupt function exits.
- When the interruption broadcast is over, the unit returns to the previous screen.
- Does not interrupt during Hands-free phone talk. During camera image display, only the sound may be interrupted.
- The volume level for the interruption broadcast can be set. For details, see “Adjusting the Radio Volume” (page 20).

## Receiving Traffic Announcement

### Touch [TA].

The “TA” indicator lights up and the unit switches to standby mode for the traffic announcement. When the traffic announcement is received, the “TP” indicator lights up and the unit switches to the radio source screen to receive it.

- The “TP” indicator lights up during standby mode off in a condition other than radio source to indicate that the unit is receiving the traffic announcement.

## Displaying Radio Text

Text messages from a radio station can be displayed.

- 1 Tune in a radio station that transmits text messages.**
- 2 Touch the information display in the FM radio mode repeatedly to switch to the desired display.**

Tag Info. Mode → Radio Text Mode → Tag Info. Mode

Tag Info. Mode:

PS Name or Frequency/PTY Name/Artist Name/Song Name

Radio Text Mode:

Frequency/Radio Text

## DAB/DAB+

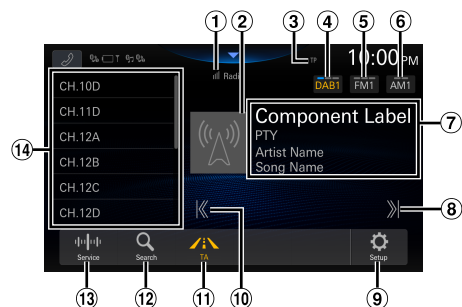

- 1** Signal Strength indicator
- 2** Slide Show  
Displays the program information, artist photos, and advertisements that are synchronised with the Service component currently being received. They may not be displayed, depending on the Service component currently being received.
- 3** TP indicator
- 4** Switch the DAB band.
- 5** Switch the FM band.
- 6** Switch the AM band.
- 7** Information display
  - For details on switching the display, see “Displaying DAB Text” (page 45).
- 8** Increases frequency  
Touch and hold to change the frequency continuously.
- 9** Displays the Radio Setup Menu screen (page 20).
- 10** Decreases frequency  
Touch and hold to change the frequency continuously.
- 11** Traffic Information mode On/Off
- 12** Displays the search screen
- 13** Switches a Seek mode.
- 14** Preset List  
Displays the preset stations with a short touch.  
Touch for at least 2 seconds to memorize the current station as a preset station.

## Listening to DAB/DAB+/DMB

### 1 Press the (HOME) button and select Radio mode.

The display shows the Radio mode screen.

### 2 Touch [DAB] to select a band.

Each touch changes the bands as follows:

DAB1 → DAB2 → DAB3 → DAB1

• For [FM] or [AM], see “Radio/RDS” (page 41).

### 3 Touch [] repeatedly to select the tuning mode.

Each time you touch, the Seek mode is switched.

Service → PTY → Preset → Service

• This button displays the currently selected mode.



Service (Service Up/ Down) mode: Service Components in the All Service list will be switched.

PTY mode: A Service (Primary Component) of the programme type currently being received is tuned in.

Preset (Preset UP/DN) mode: The Preset station will be tuned in directly.

### 4 Touch [, ] to change the Service, PTY or Preset up or down respectively.

Touch and hold to change the Service, PTY or Preset continuously.

• The ,  buttons provide the same functions above.

## Presetting Service

### 1 Select the service and PTY, and then tune in a desired service you wish to store in the preset memory.

### 2 Touch and hold the Preset number you want to store for at least 2 seconds.

The selected station is stored.

### 3 Repeat the procedure to store up to 11 other stations onto the same band.

To use this procedure for other bands, simply select the desired band and repeat the procedure.

- A total of 36 services can be stored in the preset memory. (12 stations for each band; DAB1, DAB2 or DAB3).
- If a preset memory has already been set in the preset button, it will be cleared and the new station will be memorized.

## Tuning to Preset Service

You can tune in the preset stations in memory on either band using its preset number.

### Touch any one of the preset buttons that has a service stored to it.

The preset service is received.

## Service Component/PTY Search Function

You can select your favourite Service Component from the All Service list or PTY Search list.

### Service Search Function

#### 1 Touch [] (Search).

#### 2 Touch [] (All).

All the currently available Service Component (Primary/Secondary) lists are displayed.

#### 3 Touch the desired Service Component.

The Selected service component is received.

- A Secondary Service list that was derived from the Primary Services is displayed in the Service Component list.
- The TP indicator is displayed in the Service Component (Primary) list currently being received.
- The PTY is displayed in the Service Component (Primary) list currently being received.

### PTY Search Function

#### 1 Touch [] (Search).

#### 2 Touch [] (PTY).

#### 3 Touch the desired programme type.

The Service Component list that corresponds with the selected programme type is displayed.

#### 4 Touch the desired Service Component.

The selected Service Component is received.

---

## Interruption Function

---

If Interruption Function is enabled, when the following broadcast is received, the unit switches to the DAB source screen automatically, and will receive broadcasts.

- Alarm (Emergency Broadcast)\*1, 4
- TA(Traffic Announcement)\*2, 5
- News Announcement\*3, 4

\*1 Set PTY31/Alarm Interrupt to **[On]** in “Setting the PTY31/Alarm Interrupt” (page 20).

\*2 Set TA/Traffic Interrupt to **[On]** in “Setting the TA/Traffic Interrupt” (page 20).

\*3 Set News Interrupt to **[On]** in “Setting the News Interrupt” (page 20).

\*4 Not interrupted during the RDS broadcast reception.

\*5 The Interruption Function for Traffic Announcements works with RDS broadcasts. Therefore, even if the current source is DAB, a Traffic Announcement by RDS broadcast may interrupt.

- *If no signal is received for more than 60 seconds, interrupt function exits.*
- *To cancel the Interruption function, touch **[Cancel]**.*
- *Touch **[Disable]** when interrupted, to disable the Interruption function. The setting for the interruption type becomes **[Off]**. For example, the Interruption function becomes disabled and the News Interrupt setting is set to **[Off]** by touching **[Disable]** when “News” is interrupting.*
- *When the interruption broadcast is over, the unit returns to the previous screen.*

## Receiving Traffic Announcement

Touch  (TA).

The “TA” indicator lights up and the unit switches to standby mode for the traffic announcement.

When the traffic announcement is received, the “TP” indicator lights up and the unit switches to the DAB source screen to receive it.

- *The “TP” indicator lights up during standby mode off in a condition other than the DAB source to indicate that the unit is receiving the traffic announcement.*
- *This setting works interlocked with the traffic announcement (Emergency Broadcast) of RDS.*

---

## Displaying DAB Text

---

Text messages from a DAB station can be displayed.

**1 Tune in a DAB station that transmits text messages.**

**2 Touch the information display in the DAB mode repeatedly to switch to the desired display.**

Tag Info. Mode → Dynamic Label Mode → Tag Info. Mode

Tag Info. Mode:

Service Component Label (Service ID)/PTY Name/Artist Name/Song Name

Dynamic Label Mode:

Service Component Label (Service ID)/Dynamic Label (Displays the information related to the current receiving station)

---

## Displaying the Slide Show by Enlarging

---

The area for the Slide Show in the DAB mode screen can be enlarged.

**1 Touch the Slide Show area.**

The slide image is enlarged.

**2 Touch  to return to the DAB mode screen.**

---

## About DAB/DAB+/DMB

---

**What is DAB?**

DAB (Digital Audio Broadcasting) is the third generation broadcasting technology following the traditional analogue technologies such as FM. The advantages of DAB include being more robust with regard to noise, interference, instability, etc., during radio signal transmission. Also, it can provide stereo CD-quality sound and digital information, and it can resist multipath interference guaranteeing high-quality reception for fixed, portable and mobile devices.

**What is DAB+?**

WorldDAB, the organisation in charge of the DAB standards, announced DAB+, a major upgrade to the DAB standard in 2006, when the HE-AAC v2 audio codec (also known as eAAC+) was adopted. The new standard, which is called DAB+, has also adopted the MPEG Surround audio format and stronger error correction coding in the form of Reed-Solomon coding. DAB+ has been standardised as ETSI TS 102 563.

## What is DMB?

DMB (Digital Multimedia Broadcasting) is a future-orientated, new generation broadcasting system based on DAB (Digital Audio Broadcasting). Where DAB upgraded the traditional analogue sound of FM to a CD-quality level, DMB advances simple sound broadcasting to the multimedia arena, striving to provide a visual service while transmitting high-quality sound. Users include entertainment programmes, intellectual traffic navigation, electronic newspapers and magazines, information provided by financial markets, the Internet, and integrated city information. It can be widely used by mobile carriers such as buses, taxis, light railways, underground railways, trains, ferries, airports, and by all kinds of people in the home and office.

## USB Flash drive (Optional)

You can play back music files (MP3/WMA/AAC/FLAC/WAV/APE), video files (MP4/MOV/FLV/MKV) stored in a USB flash drive on the internal player of this system.

### WARNING

**It is dangerous for the driver to watch video while driving the vehicle. The driver may be distracted from looking ahead and an accident could occur.**

**Install the unit correctly so that the driver cannot watch a video unless the car is stopped and the parking brake is applied.**

**If the unit is not installed correctly, the driver will be able to watch a video while driving and may be distracted from looking ahead and cause an accident. The driver or other people could be severely injured.**

## USB Audio

### ■ USB Audio mode screen

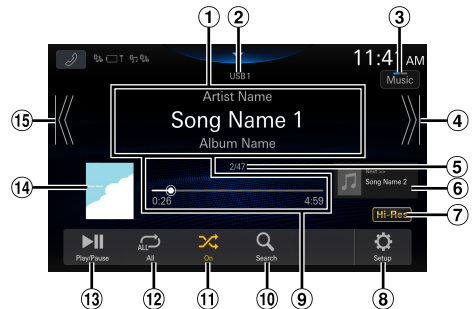

- ① Information display
- ② USB1/USB2 indicator
- ③ Switches to USB Video mode
- ④ Finds the beginning of next chapter/Fast-forwards when touched for at least 1 second
- ⑤ Current track number/Total track number
- ⑥ Next song information display
- ⑦ Hi-Res icon display
  - Not displayed if the following conditions are not satisfied.
    - Extension: .flac/.wav
    - Sampling frequency: 96 kHz or more
    - Quantization bit rate: 24 bit or more

- ⑧ Displays the USB Setup Menu screen (page 21)
- ⑨ Time Bar (Elapsed time/Total time for playing)
- ⑩ Displays the search screen
- ⑪ Shuffle mode
- ⑫ Repeat mode
- ⑬ Pause and Play
- ⑭ Artwork display
- ⑮ Finds the beginning of the current file/Finds a previous file within 3 seconds after playback starts/Fast-reverses when touched for at least 1 second

---

## Playback

---

### 1 Press the (HOME) button and select USB mode.

The display shows the USB mode screen.

- When in USB Video mode, touch [Video] to switch to USB Audio mode.

### 2 Touch [] or [] to select the desired track (file).

**Returning to the beginning of the current (or previous) track (file):**

Touch [].

**Fast reverse :**



Touch and hold [].

**Advancing to the beginning of the next track (file) :**

Touch [].

**Fast forward :**

Touch and hold [].

- The ,  buttons provide the same functions above.
- Touch or slide the Time Bar to fast-forward or fast-reverse.

### 3 To pause playback, touch [].

Touching [] again will resume playback.

- If there is tag information, artist name/album name/track name is displayed.
- ID3 tag/WMA tag  
If an MP3/WMA/AAC/FLAC/WAV/APE file contains ID3 tag/WMA tag information, the ID3 tag/WMA tag information is displayed. (e.g., song name, artist name, and album name)

---

## Repeat Play

---

Touch [, [] or [] to select Repeat Play mode.

All : All files are repeatedly played back.

File : Only the file currently playing is repeatedly played back.

Folder : Only files in a folder are repeatedly played back. Only available when a file is played back by searching a Folder.

---

## Shuffle Play

---

Touch [] to select Shuffle Play mode.

On : Songs in the selected category (artist, album, etc.) are played back in random order. Songs in the category are played back only once until all songs are played back.

Off : Shuffle mode is Off.

## Searching for a Desired Song

This unit can make various searches using the search function as shown below.

Using the Song/Artist/Album/Genre/Folder search mode's individual hierarchy, you can narrow down your search as shown in the table below.

### <Music Search Menu>

Hierarchy 1	Hierarchy 2	Hierarchy 3	Hierarchy 4
Songs	—	—	—
Artists	Albums	Songs	—
Albums	Songs	—	—
Genres	Artists	Albums	Songs
Folder	File	—	—

### For example: Searching by Artist name

The following example explains how an Artists search is performed.

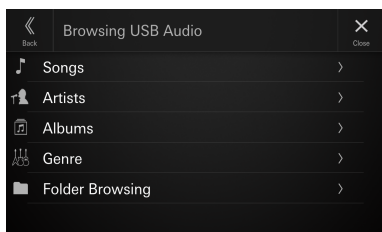

**1 Touch [Q] (Search) during playback.**

**2 Touch [Artists].**

The Artists search screen is displayed.

**3 Touch the desired artist's name.**

**4 Touch the desired album's name.**

All songs of the selected album are displayed.

**5 Touch the desired song's name.**

The selected song is played back.

## USB Video

The video formats (USB Flash drive) supported by the unit are as follows.

- Supported Container: MP4/MOV/FLV/MKV
- Supported Video Coding: MPEG-4/H.263/H.264 (MPEG-4/AVC)/MPEG-1/MPEG-2
- Supported Audio Coding: MP3/WMA/AAC/WAV/FLAC/APE

### ■ USB Video mode screen

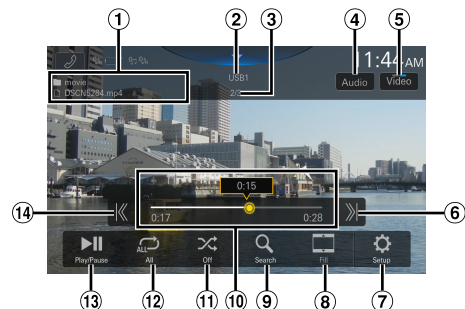

① Folder Name/File Name

② USB1/USB2 indicator

③ Current file number/Total file number

④ Changes the Audio Tracks (Only during MKV file playback)

⑤ Switches to USB Audio mode

⑥ Finds the beginning of next file/Fast-forwards when touched for at least 1 second

⑦ Displays the USB Setup Menu screen (page 21)

⑧ Switching Display Modes

⑨ Displays the search screen

⑩ Time Bar (Elapsed time/Total time for playing)

⑪ Shuffle mode

⑫ Repeat mode

⑬ Pause and Play

⑭ Finds the beginning of the current file/Finds a previous file within one second after playback starts/Fast-reverses when touched for at least 1 second



---

## Playback

---

### 1 Press the (HOME) button and select USB mode.

The display shows the USB mode screen.

- When in USB Audio mode, touch [Music] to switch to USB Video mode.

### 2 During the USB Video playback, touch the screen to display the operation screen.

The USB Video operation screen is displayed for about 5 seconds.



### 3 Touch [] or [] to select the desired track (file).

Returning to the beginning of the current (or previous) track (file):

Touch [].

Advancing to the beginning of the next track (file):

Touch [].

- The [], [] buttons provide the same functions above.

### 4 To pause playback, touch [].

Touching [] again will resume playback.

- For your safety, video is not displayed and only audio can be heard while driving.

---



## Fast-forwarding/Fast-reversing

---

### 1 During playback, touch and hold [] (Fast-reverse) or touch and hold [] (Fast-forward).

- Touch and hold for more than 1 second to forward/reverse at 2x speed. Keep touching to switch the speed to 3x, 8x, 16x and 32x.

### 2 Release [] or [] to return to normal playback.



- The [], [] buttons provide the same functions above.
- Touch or slide the Time Bar to fast-forward or fast-reverse.

---

## Repeat Play

---

### Touch [], [] or [] to select Repeat Play mode.



- All : All files are repeatedly played back.
- File : Only the file currently playing is repeatedly played back.
- Folder : Only files in a folder are repeatedly played back.

---

## Shuffle Play

---

Touch [] to select Shuffle Play mode.

- On : Files in the selected folder are played back in random order. Files in the category are played back only once until all files are played back.
- Off : Shuffle mode is Off.

---

## Searching for a Desired file

---

### 1 Touch [] (Search).

### 2 Touch your desired Folder name or File name.

- When you select a Folder name, repeat the same procedure to select another Folder name or File name.

## Switching Display Modes

You can switch the Display Mode while playing a Video File.

### Touch the Display Mode button.

Each time you touch, the Display Mode is switched.

Fit → Fill → Fit

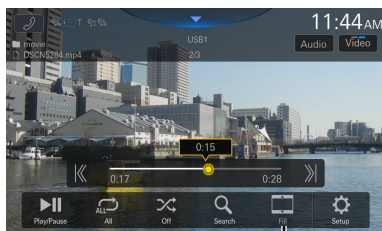

Display Mode button

- The Display Mode button displays the currently selected mode.
- You cannot operate them while driving.

Fit: The mode displays a picture to fit its size vertically and horizontally with the monitor size.

Fill: Cut the top and bottom of the image and stretch it over the entire screen.

## Switching the Audio Tracks

When the image has multiple sound tracks, the sound track can be switched during playback or pausing.

### Touch [Audio].

The sound switches in order each time it is touched. The format of the sound is displayed on the screen.

- If more than one audio is not recorded in the video, the [Audio] button will not be displayed.

## iPod mode on iPhone (Optional)

A separately sold Lightning to USB cable, etc., is required.

- This unit does not support video playback from an iPhone which connected to this unit via the USB Connector.
- Internet or telephone function, etc., of the iPhone is not controllable from the unit, but these functions can be controlled using the iPhone itself.
- When an iPhone is connected, Apple CarPlay mode is turned on. To use you iPhone with iPod mode, turn "off" the CarPlay setting on the iPhone.

### ■ iPod main screen example



- ① Information display\*
- ② Finds the beginning of next chapter/Fast-forwards when touched for at least 1 second
- ③ Current song no./Total song no.
- ④ Next song information display
- ⑤ Displays the iPod Setup Menu screen (page 22)
- ⑥ Time Bar (Elapsed time/Total time for playing)
- ⑦ Displays the search screen
- ⑧ Shuffle mode
- ⑨ Repeat mode
- ⑩ Pause and Play
- ⑪ Artwork display
- ⑫ Finds the beginning of the current file/Finds a previous file within 3 seconds after playback starts/Fast-reverses when touched for at least 1 second

\* Podcast mode.

## Playback

### 1 Press the (HOME) button and select iPod mode.

The display shows the iPod mode screen.

### 2 Touch [] or [] or to select the desired track (file).

#### Returning to the beginning of the current (or previous) track (file):

Touch [].

#### Fast reverse the current track :



Touch and hold [].

#### Advancing to the beginning of the next track (file) :



Touch [].

#### Fast forward the current track :

Touch and hold [].

- The  and  buttons provide the same functions above.
- Touch or slide the Time Bar to fast-forward or fast-reverse.

### 3 To pause playback, touch [].

- If a song is playing on the iPhone before it is connected to the unit, it will continue playing when it is connected.
- Audiobooks may have several chapters. The chapter can be changed by touching [] or [].
- If the artist, album or song name, created in iTunes, has too many characters, songs may not be played back when connected to the unit. Therefore, a maximum of 64 characters is recommended. The maximum number of characters for the unit is 64.
- Some characters may not be correctly displayed.

## Searching for a Music File

An iPhone can contain thousands of songs. For this reason, this unit can make various searches using the search function as shown below.

Using the Playlists/Artists/Albums/Podcasts/Audiobooks/Genres/Composers/Songs/Radio search mode's individual hierarchy, you can narrow down your search as shown in the table below.

#### <Music Search Menu>

Hierarchy 1	Hierarchy 2	Hierarchy 3	Hierarchy 4
Playlists	Songs	—	—
Artists	Albums	Songs	—
Albums	Songs	—	—
Songs	—	—	—
Genres	Artists	Albums	Songs
Composers	Albums	Songs	—
Podcasts	Episodes	—	—
Audiobooks	—	—	—
Radio	—	—	—

#### For example: Searching by Artist name

The following example explains how an Artists search is performed.

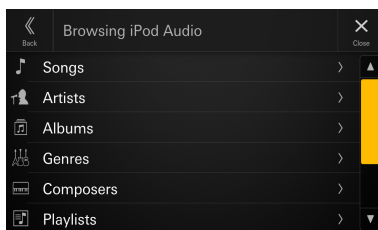

### 1 Touch [] (Search) during playback.

### 2 Touch [Artists].

The Artists search screen is displayed.

### 3 Touch the desired artist's name.

### 4 Touch the desired album's name.

All songs of the selected album are displayed.

### 5 Touch the desired song's name.

The selected song is played back.

---

## Repeat Play

---

Touch [  ] to select Repeat Play mode.

All Tracks : All songs are repeatedly played back.

Single Track : Only the song currently playing is repeatedly played back.

Off : Repeat mode is Off.

---

## Shuffle Play

---

Touch [  ] to select Shuffle Play mode.

Album : The songs on each album are played back in proper order. Upon completing of all the songs on the album, the next album is selected randomly. This continues until all albums have been played.

Songs : Randomly plays back songs within a selected category (playlist, album, etc.). The songs within the category are played just once until all songs have been played.

Off : Shuffle mode is Off.

## HDMI Device (Optional)

Devices supporting HDMI can connect and play back through this unit (for example, iPhone or other Smartphones).

- The HDMI/MHL connecting cable differs depending on the connected device corresponding to HDMI. Prepare optional HDMI/MHL connecting cable sets suitable for your device.

### WARNING

**It is dangerous for the driver to watch video while driving the vehicle. The driver may be distracted from looking ahead and an accident could occur.**

**Install the unit correctly so that the driver cannot watch video unless the car is stopped and the parking brake is applied.**

**If the unit is not installed correctly, the driver will be able to watch video while driving and may be distracted from looking ahead and cause an accident. The driver or other people could be severely injured.**

## HDMI Operation

### ■ iPhone, Smartphone, etc.

The output of your electronic device will be mirrored on this unit through the HDMI connector. Control from this unit is not possible.

- In HDMI player mode, the screen of the device displays the content of electronic equipment by mirror image.
- The electronic device must possess an HDMI output interface.
- Not all devices with an HDMI output interface can be recognised by this unit.
- Use only the Alpine Special HDMI connection cable.

### 1 Press the (HOME) button to select HDMI.

The display shows the HDMI mode screen.

### 2 During the HDMI playback, touch and hold the screen to display the operation screen.

The HDMI operation screen is displayed for about 5 seconds.

- For your safety, video is not displayed and only audio can be heard while driving.

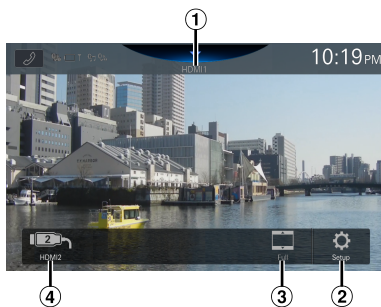

- ① Source Title
  - The name which is given as the source name in “Setting the HDMI Name” (page 23) is displayed.
- ② Displays the HDMI Setup Menu screen (page 23)
- ③ Switching Display Modes
- ④ HDMI1/HDMI2 switch
  - This switch appears when the HDMI Selector setting is [On]. See “Setting the HDMI Selector” (page 23). The switch name of HDMI1 becomes the same as the source title.

## Switching the HDMI Input

When the optional HDMI Selector is connected, up to 2 HDMI devices can be connected. The HDMI devices can be switched during HDMI playback.

- Make sure to set the HDMI Selector setting to [On]. See “Setting the HDMI Selector” (page 23).
- The displayed name of HDMI1 varies according to the HDMI Name setting. See “Setting the HDMI Name” (page 23).

### Touch [HDMI1 (or Digital TV)] or [HDMI2].

The current HDMI mode can be checked in the Source Title located in the upper part of the HDMI operation screen.

## Switching Display Modes

You can switch the Display Mode while playing a Video File.

### Touch the Display Mode button.

Each time you touch, the Display Mode is switched.

Full → NORMAL → WIDE → Full

- *The Display Mode button displays the currently selected mode.*
- *You cannot operate them while driving.*

WIDE:	Cut the top and bottom of the image and stretch it over the entire screen.
Full:	The mode displays a picture to fit its size vertically and horizontally with the monitor size.
NORMAL:	Select when viewing 4:3 images. A black band appears on both sides of the screen.

## Bluetooth Operation

### Setup Before Using

#### About Bluetooth

Bluetooth is a wireless technology allowing communication between a mobile device or personal computer over short distances. This enables a hands-free call or data transmission between Bluetooth compatible devices. Bluetooth transmission is available in the unlicensed 2.4 GHz spectrum if the distance between devices is within 10 meters. For details, refer to the Bluetooth website (<http://www.bluetooth.com/>).

- *Depending on the Bluetooth version, a Bluetooth compatible device may not be able to communicate with this unit.*
- *Proper function of this unit with all Bluetooth compatible devices is not guaranteed. For handling of the Bluetooth compatible device, consult your Alpine dealer or Alpine website.*
- *Depending on the surroundings, Bluetooth wireless connection may be unstable.*
- *When you place a call, or perform setup operations, be sure to stop your car in a safe place.*
- *Depending on the connected Bluetooth compatible device(s), the function may differ. Also refer to the Owner's Manual of the connected device(s).*

#### About the Hands-free Phone

Hands-free calls are possible when using a HFP (Hands-Free Profile) compatible mobile phone with this unit.

- *Avoid performing a hands-free call in heavy traffic or on narrow or winding streets.*
- *Close the windows while calling to reduce background noise.*
- *If both calling parties are using hands-free devices, or the call is made in a noisy location, difficulty hearing the other person's voice is normal.*
- *Depending on telephone line conditions or certain mobile devices used, voices may sound unnatural.*
- *When using a microphone, speak as directly as you can into the microphone to obtain the best sound quality.*
- *Certain mobile phone features are dependent on the capabilities and settings of your service provider's network. Additionally, certain features may not be activated by your service provider, and/or the provider's network settings may limit the feature's functionality.*

*Always contact your service provider about feature availability and functionality.*

*All features, functionality, and other product specifications, as well as the information contained in the Owner's Manual are based upon the latest available information and are believed to be accurate at the time of printing.*

*Alps Alpine reserves the right to change or modify any information or specifications without notice or obligation.*

- *Notice that when you connect an iPhone 6s or later/Android smartphone with installed Android Auto App, the operation screen may differ from this section.*

## Before Using Bluetooth

Before using the hands-free phone/audio function, the following settings need to be made.

- 1 Set "Bluetooth" to [On] (page 18).
- 2 Register a Bluetooth device in this unit (page 15).

- You can search for this unit using a Bluetooth compatible device, and then connect that Bluetooth compatible device to this unit. The device name of this unit is "iLX-507A", "iLX-F509A" or "iLX-F511A" and the initial number of the passcode is "0000." Also refer to the Owner's Manual of the connected device(s).

## Hands-free Phone Control

Touch [  ] (Phone) in the HOME screen or Source mode screen to display the Phone menu screen.

Phone button

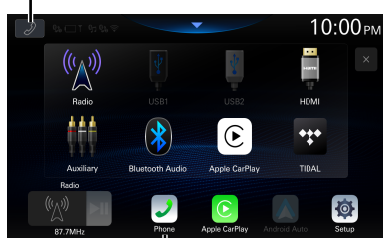

Phone button

- The Device List screen is displayed when a Hands-free Phone, Apple CarPlay or Android Auto device is not connected.

### ■ Phone menu screen example

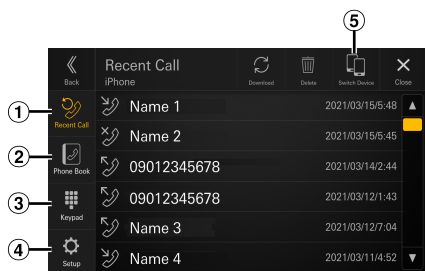

#### ① Recent Call

You can display up to 90 items, such as phone numbers of the most recent incoming calls, missed calls and outgoing calls, and contact names that are registered in the Phone Book. When 90 items exist in the list, the oldest item is deleted when a further item is to be added.

- ② Phone Book  
You can make a phone call from the Phone Book.
- ③ Keypad screen  
Use to type a phone number.
- ④ Setup  
Displays the Phone Setup Menu screen (page 23).
- ⑤ Switch Device  
You can switch between Hands Free 1 and Hands Free 2.

## Answering a Call



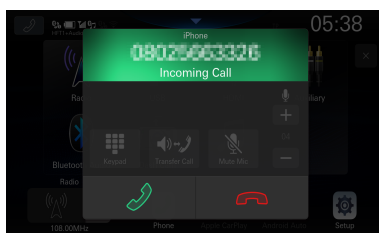

### 1 An incoming call triggers the ringtone and an incoming call display.

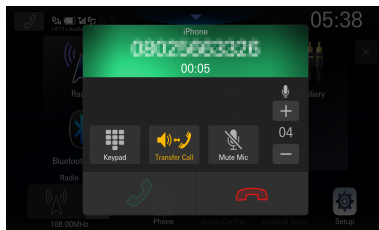

### 2 Touch [ ].

The call starts.



- During a call, the audio for the current mode on the unit is muted. After calling, playback will resume.
- When the caller's number is transmitted to the system, if the caller's name is stored in the phone book, the name is displayed. If the name is not stored, the number is displayed.
- Touch [  ] (Decline) to reject an incoming call.
- By touching [  ], you can mute the microphone. To cancel MUTE mode, touch [  ]. For details, see "Phone Operation Screen" (page 56).
- When 2 Bluetooth compatible devices are connected, one is in a call and the other receives an incoming call, the screen indicates the incoming call. To answer the second call, hang up the first call, and then touch [  ] on the screen of this unit. Or you can answer the call directly with your Bluetooth compatible device.

## Hanging up the Telephone

Touch [  ] (End Call).

The call finishes.

## Calling

### Making a phone call using the Phone Menu

#### Making a phone call from the Recent Events list

**1 Touch [Recent Call] on the Phone menu.**

The Recent Call screen is displayed.

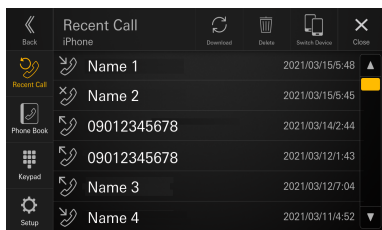

**2 Touch the name of the contact you want to call.**

The phone call is started.

#### Calling from the Phone Book

**1 Touch [Phone Book] on the Phone menu.**

The Phone Book screen appears.

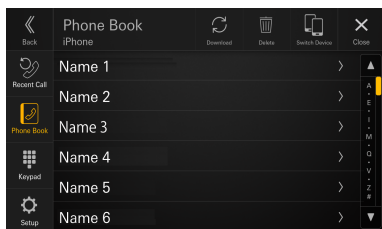

**2 Touch the name of the contact you want to call.**

The Detail info screen is displayed.

**3 Touch the phone number.**

The phone call is started.

#### Entering a Phone Number to Make a Call

**1 Touch [Keypad] on the Phone menu.**

The number input screen (Keypad) appears.

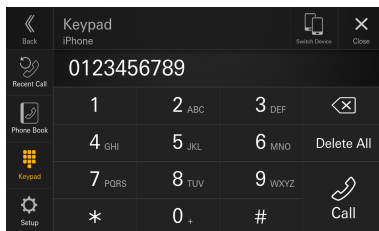

Touch [  ] to delete an entered number.

Touch [Delete All] to delete all entered numbers.

**2 Enter the phone number you wish to call.**

• You can enter up to 40 digits.

**3 Touch [  ] (Call).**

The phone call is started.

## Phone Operation Screen

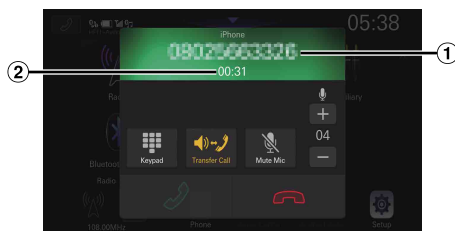

**① Name or phone number**

• If it is registered with a Group, the Group Name is also displayed. Although, depending on the connected mobile phone, it may not be displayed.

**② Conversation time**

### Adjusting the Speech Volume

You can adjust Microphone Level.

Touch [ - ] or [ + ] of .



You can adjust the volume in 11 levels.

• Microphone Level can also be adjusted in the Phone Setup screen. "Adjusting the Microphone Level" (page 24).



## Changing the Voice Output

The voice output for calls is switchable between car speakers and the mobile phone speaker.

Touch [  ] or [  ].

- Depending on the mobile phone, this operation may not be possible.

## Muting the Microphone

Touch [  ].

- To cancel MUTE mode, touch [  ].

## DTMF (Touch-Tone) Function

Transmits a DTMF (Touch-Tone) signals during a call.

**1** Touch [  ] (Keypad).

The number input screen (Keypad) appears.

**2** Input number.

- You can transmit a Touch-Tone signal during a call.
- You cannot hear the DTMF (Touch-Tone) signal.

## Phone Book Function

### ■ Phone Book screen example

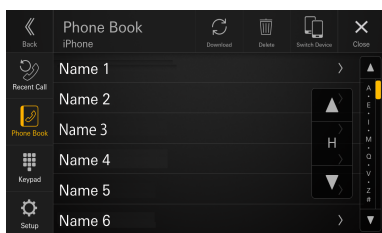

## Searching in the Phone Book

The unit is provided with an alphabet search function for effective searching. When you use this function in the search mode, you can quickly search a name, etc. of the contact which you want to call.

**1** Touch the initial search bar on the Phone Book screen and slide your finger up and down to align the bar with the target letter.

**2** Touch the name of the contact you want to call.

The Detail info screen is displayed.

**3** Touch the phone number.

The phone call is started.

- If there are no names in the list beginning with that letter, the next letter of the alphabet is searched. For example: If there are no names beginning with "R," the search list begins with "S."

## Synchronising the Phone Book

You can synchronise the system's phone book with the mobile phone's phone book.

Touch [  ] (Download) on the Phone Book screen.

Synchronisation of the phone books starts.

- You can store up to 2,000 registered name in the phone book.
- You can store up to 5 phone numbers by one person's name.

## Deleting the Phone Book Entries

**1** Touch [  ] (Delete) on the Phone Book screen.

The confirmation screen is displayed.

**2** Touch [OK].

All entries of the phone book are deleted.

# Bluetooth Audio

If a Bluetooth compatible mobile phone, portable player, etc. is connected by wireless, you can play back a song (operation is controllable from the unit).

- Operation may vary, depending on the Bluetooth compatible device.

## ■ Bluetooth Audio main screen example



- ① Information display
- ② Finds the beginning of next chapter/Fast-forwards when touched for at least 1 second
- ③ Current track number/Total track number
- ④ Displays the audio codec information (SBC/AAC/LDAC)
- ⑤ Displays the BT Audio Setup Menu screen (page 24).
- ⑥ Displays the Device Setup Menu screen (page 14).
- ⑦ Elapsed time/Total time for playing
- ⑧ Displays the search screen
- ⑨ Shuffle mode
- ⑩ Repeat mode
- ⑪ Pause and Play
- ⑫ Finds the beginning of the current file/Finds a previous file within 3 seconds after playback starts/Fast-reverses when touched for at least 1 second

- The displayed onscreen buttons may differ depending on the AVRCP version.
- To play back audio, a mobile phone or a portable player conforming to A2DP (Advanced Audio Distribution Profile) or AVRCP (Audio/Video Remote Control Profile) is required. Not all functions work with all devices.
- During a call, sound on the Bluetooth audio source is paused.

### Compatible AVRCP versions: 1.6

- Available functions may differ depending on the AVRCP version.

# Playback

## 1 Press the (HOME) button and select Bluetooth Audio mode.

The display shows the Bluetooth Audio mode screen.

- When the Bluetooth is set to [Off], the Bluetooth audio source icon will not be displayed. See "Setting the Bluetooth" (page 18).

## 2 Touch [] or [] to select the desired track (file).

### Returning to the beginning of the current file:

Touch [].

### Fast backward the current file:

Touch and hold [].

### Advance to the beginning of the next file:

Touch [].

### Fast forward the current file:

Touch and hold [].

- The and buttons provide the same functions above.

## 3 To pause playback, touch [].

# Repeat Play

## Touch [] repeatedly to select Repeat Play mode.

- |              |   |
|--------------|---|
| Single Track | Only the track currently playing is repeatedly played back.                                       |
| Group        | Only files in a group are repeatedly played back.   |
| All Tracks   | Once all of the songs have finished playing, play back is repeated, starting with the first song. |
| Off          | Repeat mode is Off.   |

- Operations may differ depending on the connected Bluetooth compatible device.

---

## Shuffle Play

---

Touch [] to select Shuffle Play mode.

Group : A Group is selected randomly and songs in the Group are played back in order. After all songs are played in the Group, the next Group is selected randomly.

All Tracks : All songs in the Bluetooth compatible devices are played back in random sequence. Any one song does not play back again until all songs have been played back.

Off : Shuffle mode is Off.

- Operations may differ depending on the connected Bluetooth compatible device.

---

## Searching for a Desired file

---

**1** Touch [] (Search).

**2** Touch your desired Folder name or File name.

- When you select a Folder name, repeat the same procedure to select another Folder name or File name.

---

## Connecting a Bluetooth Device

---

Registering a Bluetooth device in the unit enables automatic connection.

If it does not connect automatically, run through the connection procedure again.

**1** Touch [] (Phone Setting).

The Device List screen is displayed.

**2** Touch [Connect].

Bluetooth connection will start.

- For details, see “Displaying Device List” (page 14).

## Disconnecting the Bluetooth Connection

**1** Touch [] (Phone Setting).

The Device List screen is displayed.

**2** Touch [Disconnect].

The Bluetooth connection is disconnected.

- For details, see “Disconnecting the Connected Device” (page 15).

## Switching the connecting Bluetooth Device

If multiple Bluetooth devices are registered in this device, you can change the connection among the registered devices.

**1** Touch [] (Phone Setting).

The Device List screen is displayed.

**2** Select the function of the connecting device on the Function Select screen, and touch [OK].

The Function Select screen is displayed.

**3** Select [Bluetooth Audio] in the Function Select screen, then touch [OK].

A check mark is displayed for the selected function.

The connection will transfer to the selected device.

- For details, see “Connecting the Device Registered in the Device List” (page 15).

# TIDAL Operation (Optional)

To use TIDAL, it is necessary to connect to a Wi-Fi access point with a valid internet connection. For details, see “Setting the Wi-Fi Mode” (page 16) and “Connecting to Wi-Fi Access Point” (page 16).

Log in to TIDAL before using this feature. For details, see “Logging in to TIDAL” (page 60).

- For details on TIDAL, see the TIDAL website (<https://tidal.com/>).
- This unit does not support video playback.
- In areas with poor internet connectivity, it may take some time before a screen is displayed or playback starts. If the connection speed is slow, set the “Streaming Quality” setting (page 27) to “Normal”.

## ■ TIDAL main screen example

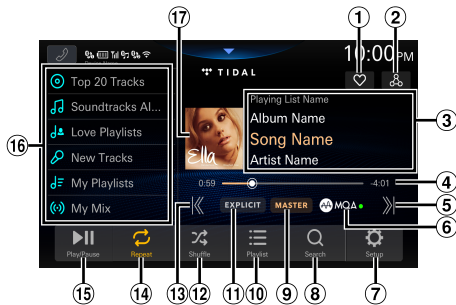

- ① Displays the Favourite Select screen (page 63)
- ② Displays the Related Searches screen (page 63)
- ③ Information display  
Playlist Name/Album Name/Song Name\*/Artist Name
- ④ Time Bar (Elapsed time/Total time for playing)\*
- ⑤ Finds the beginning of next track
- ⑥ MQA (Master Quality Authenticated) indicator  
Green light: MQA  
Blue light: MQA Studio
- ⑦ Displays the TIDAL Setup Menu screen (page 27)
- ⑧ Displays the search screen
- ⑨ Sound quality display  
Displays the sound quality of the song being played.  
MASTER/HIFI/HIGH or NORMAL
- ⑩ Displays the browsing list screen (page 62)
- ⑪ EXPLICIT indicator  
Lights up when the lyrics contain obscene and explicit expressions.
- ⑫ Shuffle mode

- ⑬ Finds the beginning of the current track/Finds a previous file within 3 seconds after playback starts
- ⑭ Repeat mode
- ⑮ Pause and Play
- ⑯ Preset list  
Recalls an item added to the preset list.  
Touch for at least 2 seconds to memorize the URL of the current playlist as a preset list.
- ⑰ Artwork display

\* The color of the Song Name and Time Bar changes depending on the sound quality.

- TIDAL Gold: MASTER quality
- TIDAL Cyan: HIFI quality
- White: HIGH or NORMAL quality

### About MQA (Master Quality Authenticated)

This unit includes MQA Core Decoder, which unfolds the MQA stream once to deliver better than CD-quality. The first unfold recovers all the direct music-related information. Output is 88.2 kHz or 96 kHz.

The [MQA+] indicator glows green or blue to indicate that the unit is decoding and playing an MQA stream, and denotes provenance to ensure that the sound is identical to that of the source material. It glows blue to indicate it is playing an MQA Studio stream, which has either been approved in the studio by the artist/producer or has been verified by the copyright owner.

## Logging in to TIDAL

When using TIDAL for the first time, if your device authentication has expired or if you are logged out, you will need to log in to TIDAL.

### 1 Press the [HOME] button and select TIDAL mode.

The TIDAL screen is displayed.

### 2 Touch [Link Account].

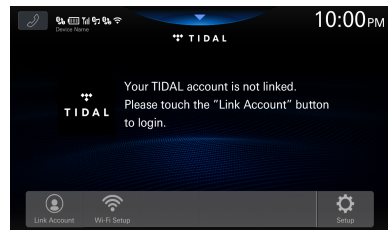

The login screen is displayed.

- 3 Scan the QR code with your iPhone or smartphone on the login screen and enter your user name and password on the login site.

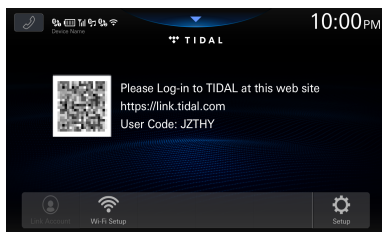

If the login is successful, the TIDAL screen will be displayed.

- If you access the TIDAL login site directly, it is necessary to enter the user code.
- When you touch [Wi-Fi Setup], the Wi-Fi Access Point List screen is displayed. For details, see “Connecting to Wi-Fi Access Point” (page 16).

## Playback

- 1 Press the  (HOME) button and select TIDAL mode.

The display shows the TIDAL mode screen.



- 2 Touch [⏮] or [⏪] or to select the desired track (file).

Returning to the beginning of the current (or previous) track:

Touch [⏮].

Advancing to the beginning of the next track:

Touch [⏪].

- The  and  buttons provide the same functions above.
- Touch or slide the Time Bar to fast-forward or fast-reverse. The message “Please wait” is displayed, then playback starts.

- 3 To pause playback, touch [⏸].

## Adding to the Preset List

You can add the URL of the current playlist to items in the preset list (mix, albums, artists, playlists, etc.).

- 1 Touch and hold the item in the preset list for at least 2 seconds.

The item is added to the preset list.

**Initial preset list items:**

My Mix, New Playlist, Recommended Playlist, Exclusive Playlist, New Albums, Recommended Albums, Top20 Albums, New Tracks, Recommended Tracks, Top20 Tracks, Favourite Albums, Favourite Tracks

- If you save an item to a preset list in which it is already assigned, the item on the list is replaced with the newly assigned item.

## Recalling from the Preset List

- 1 Touch the desired item in the preset list.

The item list screen is displayed.

- 2 Select the desired tile (Playlist, Album, etc.).

The track list screen is displayed.



- 3 Select the desired tile.

The selected track is played back.

- Touch [+Add Preset] to add the displayed content to the preset list. Touch the desired item on the Preset Select screen.



## Repeat Play

Touch [] or [] to select Repeat Play mode.

Single Track 	Only the track currently playing is repeatedly played back.
All Tracks 	Once all of the tracks have finished playing, play back is repeated, starting with the first track.

## Shuffle Play

Touch [] to select Shuffle Play mode.

On 	Tracks in the selected category (playlist, album, etc.) are played back in random order.
Off 	Shuffle mode is Off.

- If you touch [⏮] when the Shuffle mode is “On”, a randomly selected track (or the beginning of the current track) is played back, so you may not be able to go back to the previous track.

## Search

You can search for a track, artist, etc. you want to listen to based on Featured, Genres, Moods, or Rising.

### 1 Touch [🔍] (Search) during playback.

The Browsing screen is displayed.

### 2 Touch [Featured], [Genres], [Moods], or [Rising].

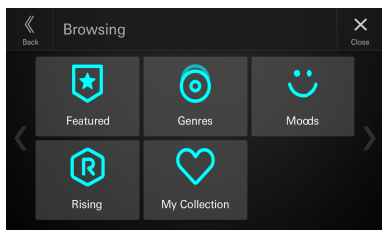

The search screen for the selected item is displayed.

### 3 Touch [Tracks], [Albums], [Playlists], or [Artists], and then select the desired tile.

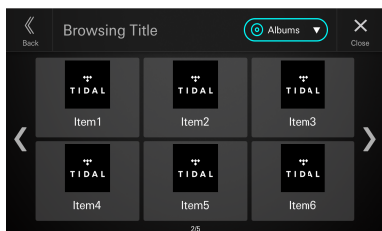

The selected track is played back.

- Content with MASTER sound quality is indicated with "M" on the tile.
- Content with EXPLICIT expressions is indicated with "E" on the tile.
- Touch [+Add Preset] to add the searched content to the preset list. Touch the desired item on the Preset Select screen.

## Search from My Collection

You can search for items added to My Collection. To add to My Collection, see "Adding to Favourite Category" and "Adding to Playlists" (page 63).

### 1 Touch [🔍] (Search) during playback.

The Browsing screen is displayed.

### 2 Touch [My Collection].

The My Collection screen is displayed.

### 3 Touch [My Mix], [Created Playlists \*1], [Favourite Playlists \*2], [Albums], [Tracks] or [Artists].

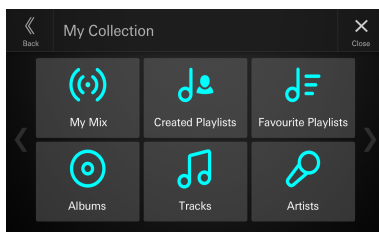

The search screen for the selected item is displayed.

\*1 Created Playlists are playlists you created in the TIDAL app on your PC or smartphone.

\*2 Favourite Playlists are TIDAL original playlists or playlists created by any user.

### 4 Select the desired tile.

The selected track is played back.

- Content with MASTER sound quality is indicated with "M" on the tile.
- Content with EXPLICIT expressions is indicated with "E" on the tile.
- Touch [+Add Preset] to add the searched content to the preset list. Touch the desired item on the Preset Select screen.

## Displaying the Playlist

You can display the playlist being played.

### 1 Touch [≡] (Playlist) during playback.

The Playlist screen is displayed.

### 2 Select the desired tile.

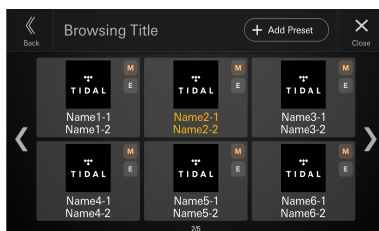

The selected track is played back.

- Content with MASTER sound quality is indicated with "M" on the tile.
- Content with EXPLICIT expressions is indicated with "E" on the tile.
- The track title being played is displayed in orange.
- Touch [+Add Preset] to add the displayed playlist to the preset list. Touch the desired item on the Preset Select screen.

---

## Adding to Favourite Category

---

You can add the track, album, playlist, or artist being played to My Collection.

### 1 Touch [♥] (Favourite Select) during playback.

The Favourite Select screen is displayed.

### 2 Touch [🎵] (Track), [🎧] (Album), [📀] (Playlist) or [👤] (Artist) of "User Favourite".

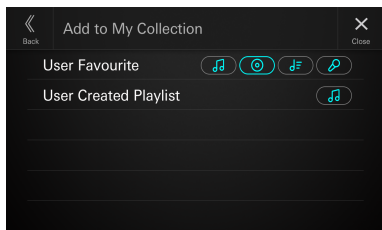

The item being played is added to the corresponding item ("Tracks", "Albums", "Favourite Playlists", "Artists") in My Collection. If the item is added successfully, the selected button frame is highlighted.

- The added items can be recalled through the My Collection search. For details, see "Search from My Collection" (page 62).
- You cannot delete items added to My Collection.

---

## Adding to Playlists

---

You can add the track being played to the playlist.

### 1 Touch [♥] (Favourite Select) during playback.

The Favourite Select screen is displayed.

### 2 Touch [🎵] (Track) of "User Created Playlist".

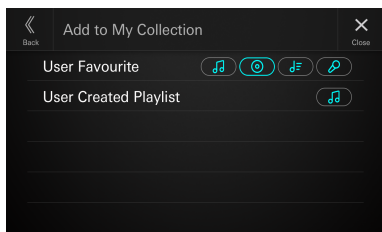

The track being played is added to "Created Playlists" in My Collection. If the track is added successfully, the selected button frame is highlighted.

- The added items can be recalled through the My Collection search. For details, see "Search from My Collection" (page 62).

- You cannot delete items added to My Collection.

---

## Search for Content Related to the Track Being Played

---

You can search for content (Track Radio, Album Browse) related to the track being played.

### 1 Touch [🔍] (Related search) during playback.

The Related Searches screen is displayed.

### 2 Touch [Track Radio] or [Album Browse].

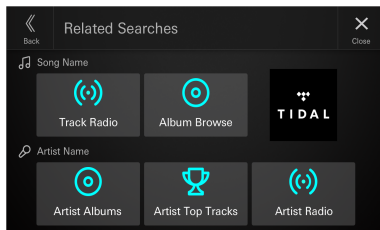

The track list screen is displayed.

### 3 Select the desired tile.

The selected track is played back.

- Content with MASTER sound quality is indicated with "M" on the tile.
- Content with EXPLICIT expressions is indicated with "E" on the tile.
- Touch [+Add Preset] to add the searched content to the preset list. Touch the desired item on the Preset Select screen.

## Search for Content Related to the Artist Being Played

You can search for content (Artist Albums, Artist Top Tracks, or Artist Radio) related to the artist being played.

### 1 Touch [ ] (Related search) during playback.

The Related Searches screen is displayed.

### 2 Touch [Artist Albums], [Artist Top Tracks] or [Artist Radio].

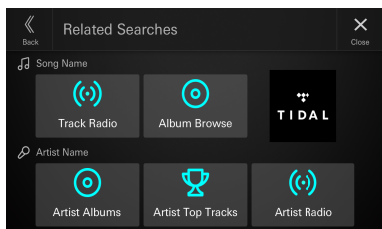

The list screen for the selected item is displayed.

### 3 Select the desired tile.

The selected track is played back.

- When you touch [Artist Albums], the track list screen is displayed, select the desired tile.
- Content with MASTER sound quality is indicated with "M" on the tile.
- Content with EXPLICIT expressions is indicated with "E" on the tile.
- Touch [+Add Preset] to add the searched content to the preset list. Touch the desired item on the Preset Select screen.

## Auxiliary Device (Optional)

### WARNING

It is dangerous for the driver to watch video while driving the vehicle. The driver may be distracted from looking ahead and an accident could occur.

Install the unit correctly so that the driver cannot watch video unless the car is stopped and the parking brake is applied.

If the unit is not installed correctly, the driver will be able to watch video while driving and may be distracted from looking ahead and cause an accident. The driver or other people could be severely injured.

## Operating Auxiliary Devices (Optional)

To operate devices connected to the AUX terminals of the unit, follow the procedure described below.

- Set up the "AUX (Auxiliary) Setup" (page 22).

### 1 Press the (HOME) button to select Auxiliary (AUX) mode.

The display shows the Auxiliary (AUX) mode screen.

### 2 During the Auxiliary (AUX) playback, touch and hold the screen to display the operation screen.

The Auxiliary (AUX) operation screen is displayed for about 5 seconds.

- For your safety, video is not displayed and only audio can be heard while driving.
- For details on the connected auxiliary device, refer to its owner's manual.



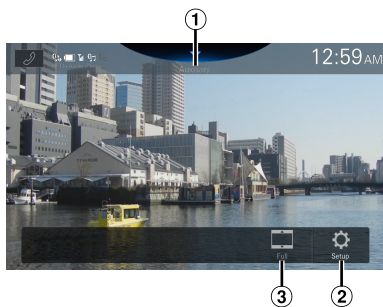

### ① Source Title

- The name which is given as the source name in "Setting the Auxiliary (AUX) Name" (page 22) is displayed.

### ② Displays the Auxiliary Setup Menu screen (page 22)

### ③ Switching Display Modes

## Switching Display Modes

You can switch the Display Mode while playing a Video File.

### Touch the Display Mode button.

Each time you touch, the Display Mode is switched.  
Full → NORMAL → WIDE → Full

- *The Display Mode button displays the currently selected mode.*
- *You cannot operate them while driving.*

WIDE:	Cut the top and bottom of the image and stretch it over the entire screen.
Full:	The mode displays a picture to fit its size vertically and horizontally with the monitor size.
NORMAL:	Select when viewing 4:3 images. A black band appears on both sides of the screen.

## Camera Operation (Optional)

When an optional camera is connected, the view of camera video can be output to the monitor.

Rear camera, Front camera (or Side camera, etc.) can be connected to this unit.

Make the Camera Select setting according to your connected camera. For details, see "Setting the Reverse Camera (Camera 1) (page 25)"; "Camera 2 Setup" (page 25).

When using the optional Multi Camera Interface module, you can connect up to 3 cameras: Front Camera, Rear Camera, and Side Camera.

When connecting the optional Multi Camera Interface module, you need to set each camera to On/Off in "Camera Selector Setup" (page 25).

### Rear camera:

If a rear camera is connected, when the vehicle is reversed, the rear camera view (guide marks for vehicle width and available distance) is displayed automatically on the screen of this unit.

### Front camera:

If a front camera is connected, it can assist to check the condition in front of the car, such as when the road visibility is bad.

### Side camera:

If a side camera is connected, it is helpful to check the condition of the road shoulder.

### Other camera:

Set when connecting to a camera other than the Front camera or Rear camera, such as a room camera.

**You can adjust the quality of the camera image.**  
**Setting items: Brightness / Colour / Contrast**  
**See "Video Setup" (page 26).**

## Rear Camera Operation

### Displaying the rear view video while the car is in reverse

#### 1 Shift the gear lever to the reverse (R) position.

The rear view image is displayed while the car remains in reverse.

#### 2 If you shift the gear lever to a position other than reverse (R), the monitor returns to the previous screen.

- *Never depend solely on the camera when backing up. Always turn and look and only use the camera for additional assistance.*
- *This function is effective when the reverse wire is properly connected.*

- You can perform a Guide Adjustment for the rear view image. For details, see “Camera Guide Setup” (page 26).

## Displaying the Camera Image from the HOME screen

### 1 Press the (CAM) button.

The Camera view image is displayed.

### 2 Touch the screen when the image from the camera is displayed.

The operation screen is displayed on the screen.

### 3 Touch [Rear].

The Rear Camera view image is displayed.

- Touch [] to return to the previous screen.
- You can perform a Guide Adjustment for the rear view image. For details, see “Camera Guide Setup” (page 26).

## Guide Display ON/OFF Setting

### 1 Touch the screen when the image from the camera is displayed.

The operation screen is displayed on the screen.

- After a 5-second time-out, the operation screen returns to the camera display screen.

### 2 Touch [Guide] on the Rear camera display screen.

The guide disappears, and then the [Guide] switch changes to [Guide].

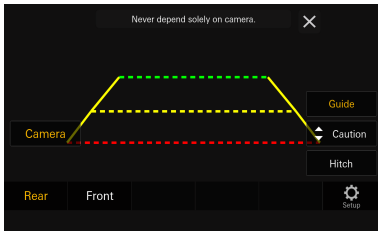

### 3 Touch [Guide] to turn on the guide.

## Adjusting the Caution Display Location

### 1 Touch the screen when the image from the camera is displayed.

The operation screen is displayed on the screen.

- After a 5-second time-out, the operation screen returns to the camera display screen.

### 2 Touch [Caution].

- For each touch, the caution location moves to the top or bottom of the screen.

## Hitch Guide Display ON/OFF Setting

### 1 Touch the screen when the image from the camera is displayed.

The operation screen is displayed on the screen.

- After a 5-second time-out, the operation screen returns to the camera display screen.

### 2 Touch [Hitch] on the Rear camera display screen.

The hitch guide appears, and then the [Hitch] switch changes to [Hitch].

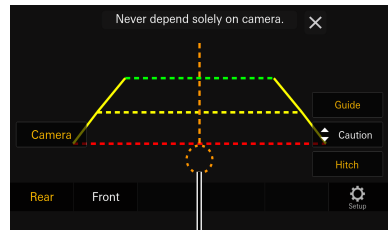

Hitch Guide

### 3 Touch [Hitch] to turn off the guide.

## About the Rear Camera Guide

To display the guide, set "Guide Display ON/OFF Setting" (page 66) to On. Also, to adjust the guide, see Camera Guide Setup" (page 26).

### ■ Indication mark meaning

When the car is put into reverse gear, the monitor switches to the rear view camera image. Guides appear to help visualize the car's width and distance from the rear bumper.

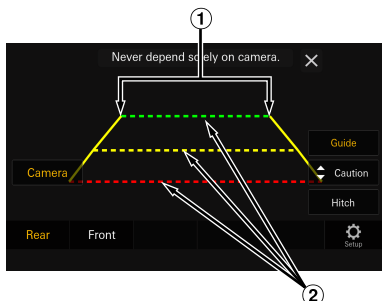

#### ① Car width extension lines (red and green in order of distance)

If properly calibrated, the marks indicate the car's width. This helps guide the car's path when backing up in a straight line.

The marks represent the distance from the rear of the car (from the rear end of the bumper).

- The marks do not move in synchronisation with the steering wheel.
- Set the marks to suit the car's width.

#### ② Distance guidance lines

The marks represent the distance from the rear of the car (from the rear end of the bumper).

- The marks do not move in synchronisation with the steering wheel.
- We recommend that you measure the actual distance to the marks when parked on a level surface.
- Depending on the condition of the car or road surface, the range of vision may vary.
- The camera has a limited range of vision. Objects at extreme angles to the camera (e.g. under the bumper or at opposite ends of the bumper) may not be in its field-of-vision.
- The rear camera image may have a tint which is different from the actual surroundings.
- Depending on the car, the guidance may deviate to the right or left. This is not a malfunction.

### ■ Distance guidance mark

The distance guides represent the ground level distance from the rear bumper. It is difficult to accurately estimate the distance to objects above ground level.

In the following example, the distance to A is 0.5 m and the distance to B is 1 m.

<Screen>

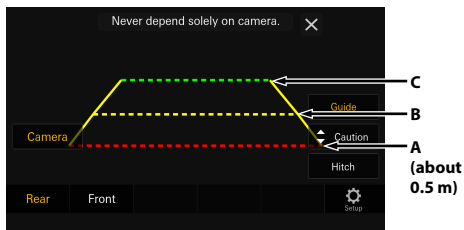

<Positions of A, B and C>

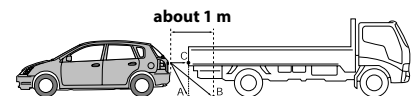

In the screen, according to the distance guidance marks, the truck seems to be parked about 1 m away (at the position B). In actual fact, however, if you reversed to position A, you would collide with the truck.

In the screen, positions A, B and C seem to be located in order of proximity. However, in actual fact, the position A and C are the same distance, and B is farther away than positions A and C.

- The car width extension mark represents the distance to the road surface. The distance to an object on the road is not accurately represented by the guides.

### Error between the screen and the actual road surface

In the following conditions, errors are produced between the screen guidance and the actual road surface. (The illustrations represent a case when the camera is installed in the standard position.)

■ **When there is a steep upward slope behind the car (example)**

<Screen>

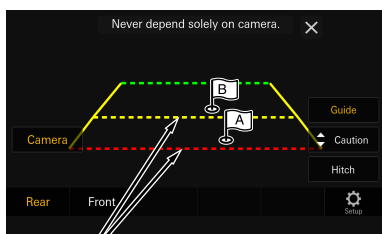

Distance guidance marks

<Situation of the car>

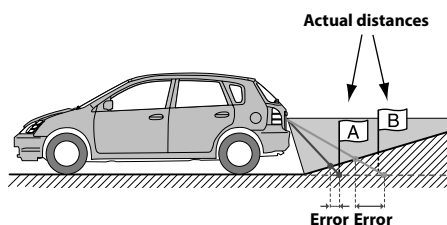

The distance guidance mark represents the distance to a flat road surface. Therefore in the case of an upward slope behind the car, the distance guides are displayed closer to the rear bumper than the actual distance. For example, if there is an obstacle on the upward slope, it may appear farther away than its actual position.

Also, an error may occur between the guidance and the actual path of the car on the road surface.

■ **When there is a steep downward slope behind the car (example)**

<Screen>

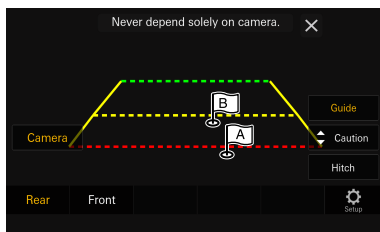

<Situation of the car>

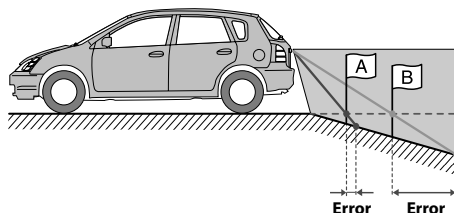

In the case of a downward slope behind the car, the distance guides are displayed farther from the rear bumper than the actual distance.

If there is an obstacle on the downward slope, it seems closer than its actual position.

Also, an error may occur between the guidance and the actual path of the car on the road surface.

## Switching the Image Pattern for the Rear Camera

If the camera has a view switch function, the Direct Change switch is displayed.

### 1 Touch the screen when the image from the rear camera is displayed.

The operation screen is displayed on the screen.

- After a 5-second time-out, the operation screen returns to the camera display screen.

### 2 Touch [View].

### 3 Touch [Back], [Panorama], [Corner] or [Top].

The image pattern changes.

- For detailed information about image patterns, see the camera Owner's Manual.
- You can perform a Guide Adjustment. For details, see "Camera Guide Setup" (page 26).

## Front Camera Operation

### Displaying the Camera Image from the HOME screen

#### 1 Press the (CAM) button.

The Camera view image is displayed.

#### 2 Touch the screen when the image from the camera is displayed.

The operation screen is displayed on the screen.

#### 3 Touch [Front].

The Front Camera view image is displayed.

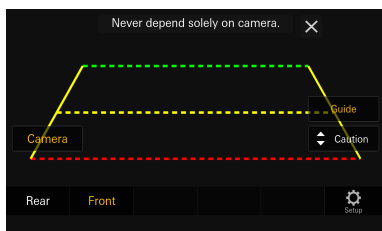

- Touch [] to return to the previous screen.
- You can perform a Guide Adjustment. For details, see "Camera Guide Setup" (page 26)

### Switching the Image Pattern for the Front Camera

If the camera has a view switch function, the Direct Change switch is displayed.

#### 1 Touch the screen when the image from the front camera is displayed.

The operation screen is displayed on the screen.

- After a 5-second time-out, the operation screen returns to the camera display screen.

#### 2 Touch [View].

#### 3 Touch [Panorama], [Corner] or [Top].

The image pattern changes.

- For detailed information about image patterns, see the camera Owner's Manual.
- You can perform a Guide Adjustment. For details, see "Camera Guide Setup" (page 26).

### About the adjustment of guide display ON/OFF setting and adjustment of Caution display location

As with the rear camera, the front camera guide display ON/OFF setting and Caution display location can be adjusted. See "Guide Display ON/OFF Setting" (page 66) and "Adjusting the Caution Display Location" (page 66) for the operations.

## Side Camera Operation

Displaying the Side Camera image from the Menu screen

#### 1 Press the (CAM) button.

The Camera view image is displayed.

#### 2 Touch the screen when the image from the camera is displayed.

The operation screen is displayed on the screen.

#### 3 Touch [Side].

The Side Camera view image is displayed.

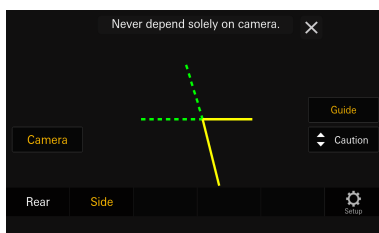

- Touch the screen while the camera image is being displayed, and touch [] to return to the previous screen.
- You can perform a Guide Adjustment. For details, see "Camera Guide Setup" (page 26).

### About the adjustment of guide display ON/OFF setting and adjustment of Caution display location

As with the rear camera, the side camera guide display ON/OFF setting and Caution display location can be adjusted. See "Guide Display ON/OFF Setting" (page 66) and "Adjusting the Caution Display Location" (page 66) for the operations.

# About Vehicle Interlock Function

Communication between your vehicle and the unit allows you to set and display various functions of your vehicle.\*<sup>1</sup> Available functions differ depending on your vehicle. For details, refer to your vehicle's instruction manual.

- A CAN Interface Box (sold separately) is required.
- Available functions differ depending on your vehicle. For details, refer to your vehicle's instruction manual.
- You can check the air conditioner settings on the Climate screen.\*<sup>2</sup>
- You can check for obstacles on the Parking Sensor screen.\*<sup>2</sup>
- You can adjust various settings for your vehicle from the unit.

\*1 Prerequisite is a compatible CAN-Interface, e.g. from the APF-X3xxx series.

\*2 When the Interruption function is set to [On], the screen changes automatically when you adjust the air conditioner or the unit detects an obstacle. For details on the Interruption setup, see "CAN I/F BOX Setting" (page 24).

## Access to Vehicle Info Mode

You can check the car's status, set the air conditioning, etc.

### 1 Press the (HOME) button to select Vehicle info mode.

- The Vehicle Info mode screen is displayed.

### 2 Touch the desired tag on the top of the screen.

Select item:

Climate / Park sensor / Car Setting

- The displayed tag options differ depending on the type of vehicle.

### 3 Adjust or confirm the item/information accordingly.

- Operable functions and displays may differ depending on the vehicle.
- By touching [Car Setting] on the Vehicle Info mode screen, you can use the unit to turn various settings related to your vehicle On/Off, set display formats, etc. For details on what functions you can set, refer to your vehicle's instruction manual.

## Function Screen example

### ■ Climate screen example

You can control the temperature inside the vehicle, etc.



### ■ Parking sensor screen example

You can check the distance from the front and rear of the vehicle to an obstacle.

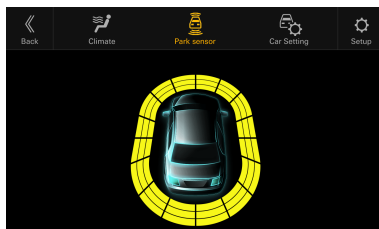

- If the car sensor detects an obstacle, the screen automatically changes to the Parking sensor screen. For details, see "About Parking Sensor screen" (page 70).

## About Parking Sensor screen

The Parking sensor screen turns on when the front or rear sensor on your vehicle detects an obstacle within a certain distance.

### Parking Sensor Full screen example

When the front or rear sensor detects an obstacle within a certain distance, the Parking Sensor screen is displayed, and the indicator that corresponds with that area lights up.

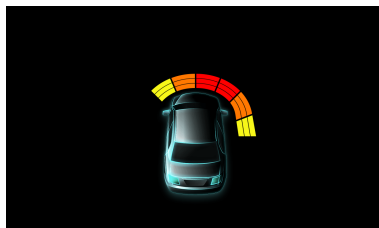

Indicator colors when an obstacle is detected.

- Red: close distance
- Orange: medium distance
- Yellow: long distance

- Depending on the speed of the vehicle, when moving faster than a certain speed, the Parking Sensor screen may not be displayed.
- Vehicles that do not have the obstacle detection sensor cannot use this function.

### **Parking Sensor Camera interlock screen example (Rear camera)**

You can check for obstacles through an interlocked camera image by connecting a Camera.

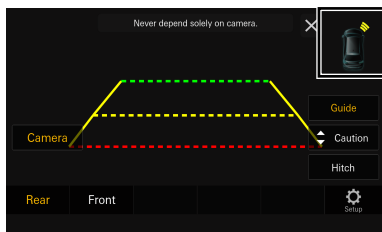

- Touch the car icon to switch to the Parking sensor full screen. (Touch [Back] on the Parking Sensor full screen to return to the Parking Sensor Camera interlock display.)
- Touch the Camera image area to switch to the Camera full screen. (While displaying the Camera full screen, touch the Camera screen, then touch [X] to return to the Parking Sensor Camera interlock screen.)
- Touch the car icon to switch to the Parking sensor full screen. (Touch [X] on the Parking Sensor full screen to return to the Parking Sensor Camera interlock display.)

### **About Car Setting screen**

In the car setting screen, you can make the settings that you would usually find in the factory radio. Some CAN interfaces have additional settings, those can be also accessed from the Car Setting screen.

### **Car Setting screen example**

Select from the list menu the function you want to set. For details of the settings see the owner's manual of the vehicle or the CAN interface.

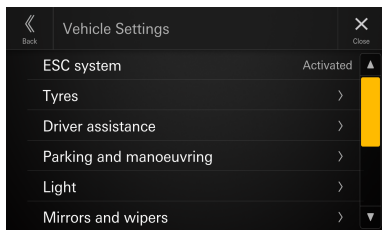

## **Information**

### **Product Software Update**

This product uses software that can be updated through a USB flash drive. Download the software from the Alpine website and update the product using the USB flash drive.

#### **Updating this product**

Check the Alpine website for details on updating.  
<https://www.alpine.com.au>

#### **Important information on the software**

##### **About the software license of the product**

The software installed in the product contains open-source software.

For details, refer to the "Open source licenses" screen on this unit. See "Displaying Software License" (page 32).

### **About the Supported Formats**

#### **About MP3/WMA/AAC/FLAC/WAV/APE**

##### **CAUTION**

**Except for private use, duplicating audio data (including MP3/WMA/AAC/FLAC/WAV/APE data) or distributing, transferring, or copying it, whether for free or for a fee, without permission of the copyright holder is strictly prohibited by the Copyright Act and by international treaty.**

#### **What is MP3?**

MP3, whose official name is "MPEG Audio Layer 3," is a compression standard prescribed by the ISO, the International Standardization Organization and MPEG which is a joint activity institution of the IEC.

MP3 files contain compressed audio data. MP3 encoding is capable of compressing audio data at extremely high ratios, reducing the size of music files to as much as one-tenth their original size. This is achieved while still maintaining near CD quality. The MP3 format realises such high compression ratios by eliminating the sounds that are either inaudible to the human ear or masked by other sounds.

#### **What is WMA?**

WMA, or "Windows Media™ Audio," is compressed audio data.

WMA is similar to MP3 audio data.

### What is AAC?

AAC is the abbreviation for "Advanced Audio Coding," and is a basic format of audio compression used by MPEG2 or MPEG4.

### What is FLAC?

FLAC (Free Lossless Audio Codec) is an audio file codec for lossless compression, developed and offered as open source software.

Codecs with lossy compression forms, such as MP3 and AAC, reduce part of the data to improve compression efficiency.

However, FLAC can reconstruct compressed data to be an identical copy of the original data by performing lossless compression. The compression ratio of FLAC is about 50%.

### What is WAV?

WAV is a standard audio format for Windows. It is the original format before compression. You can enjoy music with almost the same sound quality as a CD. WAV is also known as WAVE.

### What is APE?

APE is a format called lossless compression. It can be restored to its original quality by decoding. Mainly, it is used in "Monkey's Audio."

### Method for creating MP3/WMA/AAC/FLAC/WAV/APE (USB Flash drive) files

Audio data is compressed using software with MP3/WMA/AAC/FLAC/WAV/APE (USB Flash drive) codecs. For details on creating MP3/WMA/AAC/FLAC/WAV/APE (USB Flash drive) files, refer to the user's manual for that software.

MP3/WMA/AAC/FLAC/WAV/APE (USB Flash drive) files that are playable on this device have the file extensions.

MP3: "mp3"

WMA: "wma"

AAC: "m4a"

FLAC: "flac"/"fla"

WAV: "wav"

APE: "ape"

WMA is not supported for the following files, Windows Media Audio Professional, Windows Media Audio 10 std or Windows Media Audio 10 Pro Lossless.

There are many different versions of the AAC format. Confirm that the software being used conforms to the acceptable formats listed above. It's possible that the format may be unplayable even though the extension is valid.

Playback of AAC files encoded by iTunes is supported.

### Supported playback sampling rates and bit rates

MP3 (USB Flash drive)

Sampling rates: 8 kHz, 11.025 kHz, 12 kHz,  
16 kHz, 22.05 kHz, 24 kHz,  
32 kHz, 44.1 kHz, 48 kHz

Bit rates: 8 - 320 kbps

WMA (USB Flash drive)

Sampling rates: 8 - 48 kHz

Bit rates: 8 - 385 kbps

AAC (USB Flash drive)

Sampling rates: 16 - 48 kHz

Bit rates: 8 - 320 kbps

FLAC (USB Flash drive)

Sampling rates: 8 - 96 kHz

WAV (USB Flash drive)

Sampling rates: 8 - 96 kHz

APE (USB Flash drive)

Sampling rates: 8 - 48 kHz

This device may not play back correctly depending on sampling rates.

### ID3 tags

This device supports ID3 tag. If tag data is in an MP3/WMA/AAC/FLAC/WAV/APE file, this device can display the title (track title), artist name, and album name ID3 tag data.

For non-supported characters, "?" is displayed.

The number of characters may be limited, or not

correctly displayed, depending on the tag information.

### Playing back MP3/WMA/AAC/FLAC/WAV/APE

MP3/WMA/AAC/FLAC/WAV/APE files are prepared, then written to a USB flash drive.

- Maximum numbers of playable files/folders  
USB Flash drive: 10,000 files/folders (including Root Folder)
- Largest playable file size: 512 MB

Playback may not be performed if a USB flash drive exceeds the limitations described above.

If a file/folder name is long, the maximum possible number of files may decrease.

- Both Audio and Video files are counted if their formats are playable on this unit.

### Media supported

The media that this device can play back a USB flash drive.

### Corresponding File Systems

This device supports FAT 16/32, exFAT.

The maximum nested folder depth is 8 (including the root directory). File names are limited to 256 characters (including the extension).

Valid characters for folder/file names are letters A-Z (all caps), numbers 0-9, and '\_' (underscore).



## **Terminology**

### **Bit rate**

This is the “sound” compression rate specified for encoding. The higher the bit rate, the higher the sound quality, but also the larger the files.

### **Sampling rate**

This value shows how many times per second the data is sampled (recorded). For example, music CDs use a sampling rate of 44.1 kHz, so the sound is sampled (recorded) 44,100 times per second. The higher the sampling rate, the higher the sound quality, but also the larger the volume of data.

### **Encoding**

Converting music CDs, WAVE (AIFF) files, and other sound files into the specified audio compression format.

### **Tag**

Song information such as track titles, artist names, album names, etc., written into MP3/WMA/AAC/FLAC/WAV/APE (USB flash drive) files.

### **Root folder**

The root folder (or root directory) is found at the top of the file system. The root folder contains all folders and files. It is created automatically for all USB flash drives.

---

## **In Case of Difficulty**

---

**If you encounter a problem, please turn the power off, then on again. If the unit is still not functioning normally, please review the items in the following checklist. This guide will help you isolate the problem if the unit is at fault. Otherwise, make sure the rest of your system is properly connected, or then consult your authorized Alpine dealer.**

### **Basic**

#### **No function or display.**

- Vehicle's ignition is off.
  - If connected according to the instructions, the unit will not operate with the vehicle's ignition off.
- Improper power lead connections.
  - Check power lead connections.
- Blown fuse.
  - Check the fuse on the battery lead of the unit; replace with the proper value if necessary.

#### **No sound or unnatural sound.**

- Incorrect setting of volume/balance/fader controls.
  - Readjust the controls.
- Connections are not properly or securely made.
  - Check the connections and firmly connect.

#### **Screen not displayed.**

- Brightness/Contrast control is set at the minimum position.
  - Adjust the Brightness/Contrast control.
- Temperature in the vehicle is too low.
  - Increase the vehicle's interior temperature to operation temperature range.
- Connections to the Auxiliary Device are not securely made.
  - Check the connections and firmly connect.
- The Parking Brake Lead is not connected.
- The Parking Brake is not engaged.
  - Connect the Parking Brake Lead, then engage the Parking Brake.

#### **Movement of displayed picture is abnormal.**

- Temperature in the vehicle is too high.
  - Allow the vehicle's interior temperature to cool.

### **Radio**

#### **Unable to receive stations.**

- No antenna, or open connection in the antenna cable.
  - Make sure the antenna is properly connected; replace the antenna or cable if necessary.

#### **Unable to tune stations in the seek mode.**

- You are in a weak signal area.
  - Make sure the tuner is in Seek mode.
- If the area you are in is a primary signal area, the antenna may not be grounded and connected properly.
  - Check your antenna connections; make sure the antenna is properly grounded at its mounting location.
- The antenna may not be the proper length.
  - Make sure the antenna is fully extended; if broken, replace the antenna with a new one.

#### **Broadcast is noisy.**

- The antenna is not the proper length.
  - Extend the antenna fully; replace it if it is broken.
- The antenna is poorly grounded.
  - Make sure the antenna is grounded properly at its mounting location.
- The station signal is weak and noisy.
  - If above solution does not work, tune in another station.

#### **USB Audio**

##### **Unit does not operate.**

- Condensation.
  - Wait a while (about 1 hour) for the condensation to dry.

##### **Picture is unclear or noisy.**

- Vehicle's battery power is weak.
  - Check the battery power and wiring.  
(The unit may malfunction if the battery power is under 11 volts with a load applied.)

#### **Handsfree Phone**

##### **Ringtone is low**

- Depending on your phone, the ringtone volume may be low, it is not a failure.

---

## **If this Message Appears**

Various messages are displayed on the screen during operation. In addition to the messages telling you the current status or providing guidance for the next operation, there are also the following error messages. If one of these error messages is displayed, carefully follow the instructions in the solution column.

#### **System**

##### **Unable to operate while driving.**

- A setup operation, etc., was carried out while the vehicle was running.
  - Move the vehicle to a safe location, stop, and engage the parking brake, then carry out this operation.

---

##### **USB Hub is not supported.**

- A USB flash drive with a hub is connected.
    - You cannot play back from a USB flash drive with a hub.  
USB hub connections are also not supported.
- 

#### **Audio/Visual**

##### **Connected USB Device is not supported.**

- An iPhone that is not supported by the unit is connected.
    - Connect an iPhone that is supported by the unit.
  - A USB device that is not supported by the unit is connected.
    - Attempt to connect another USB flash drive.
  - Communication error.
    - Turn the ignition key off, and then set to ON again.
    - Check the display by reconnecting between the iPhone and the unit, using the iPhone cable.
    - Check the display by reconnecting between the USB flash drive and the unit.
  - Caused by the iPod/iPhone Software Version not being compatible with this unit.
    - Update the iPhone Software Version to be compatible with this unit.
  - The iPhone is not verified.
    - Change to another iPhone.
- 

##### **DAB Antenna error**

- The DAB antenna cable is either damaged or not connected correctly to the product.
    - Check that the antenna cable is not kinked or otherwise damaged. Replace the antenna if necessary.
  - Abnormal current is run to the DAB Antenna.
    - Connect the antenna properly to a car with a 12 volt negative ground.
- 

#### **HDMI**

##### **HDMI communication error.**

##### **Please check your device and operate it again.**

- The HDMI devices are not connected properly.
    - Remove the HDMI devices from the unit, and then reconnect them. Enable the output setting on the HDMI devices.
- 

##### **HDMI monitor communication error.**

##### **Please check the connection or ACC off / on.**

- Connection error
    - Turn OFF/ON the engine (ACC), or check the HDMI connection cable of the HDMI compatible monitor.
-

## Specifications

### MONITOR SECTION

Screen Size	7" (iLX-507A) 9" (iLX-F509A) 11" (iLX-F511A)
Operation System	TFT active matrix
Number of Picture Elements	2,764,800 pcs. (1280 × 720 × RGB)
Effective Number of Picture Elements	99% or more
Color system	NTSC / PAL
Illumination System	LED

### FM TUNER SECTION

Tuning Range	87.5 – 108.0 MHz
Mono Usable Sensitivity	8.1 dBf (0.7 $\mu$ V/75 ohms)
50 dB Quieting Sensitivity	12 dBf (1.1 $\mu$ V/75 ohms)
Alternate Channel Selectivity	80 dB
Signal-to-Noise Ratio	65 dB
Stereo Separation	35 dB

### AM TUNER SECTION

Tuning Range	531 – 1,701 kHz
Usable Sensitivity	25.1 $\mu$ V/28 dBf

### DAB SECTION

Tuning Range	174.928 – 239.2 MHz
Usable Sensitivity	-100 dBm
Signal-to-Noise Ratio	90 dB

### USB1 SECTION

USB requirements	USB 2.0
Max. Power Consumption	2,400 mA
USB Class	USB (Mass Storage Class)
File System	FAT16 / 32, exFAT
Number of Channels	2-Channels (Stereo)
Frequency Response*1	5 – 40,000 Hz ( $\pm$ 1 dB)
Total Harmonic Distortion	0.005% (at 1 kHz)

Dynamic Range	95 dB (at 1 kHz)
Signal-to-Noise Ratio	95 dB
Channel Separation	90 dB (at 1 kHz)

\*1 Frequency response may differ depending on the encoder software/bit rate.

### USB2 SECTION

USB requirements	USB 2.0
Max. Power Consumption	1,500 mA (CDP Support)
USB Class	USB (Mass Storage Class)
File System	FAT16 / 32, exFAT
Number of Channels	2-Channels (Stereo)
Frequency Response*1	5 – 40,000 Hz ( $\pm$ 1 dB)
Total Harmonic Distortion	0.005% (at 1 kHz)

Dynamic Range	95 dB (at 1 kHz)
Signal-to-Noise Ratio	95 dB
Channel Separation	90 dB (at 1 kHz)

\*1 Frequency response may differ depending on the encoder software/bit rate.

### HDMI SECTION

Input Format	720p / 480p / VGA
Output Format	720p / 480p

### Bluetooth SECTION

Bluetooth Specification	Bluetooth V4.2 (2,402 - 2,480 MHz)
Output Power	+4.0 dBm/2.51 mW Ave. (Power class 2)
Profile	HFP (Hands-Free Profile) OPP (Object Push Profile) PBAP (Phone Book Access Profile) SPP (Serial Port Profile) A2DP (Advanced Audio Distribution Profile) AVRCP (Audio/Video Remote Control Profile)

### GPS SECTION

Reception Frequency	1575.42 + / - 1.023 MHz
Reception sensitivity (Search)	-136 dB max.

## **Wi-Fi SECTION**

Frequency Ranges	IEEE 802.11 b/g/n (2.4 GHz) IEEE 802.11 a/n/ac (5 GHz)
Channels	1 – 13 ch (2.4 GHz) 149 - 165 ch (5 GHz)
Security Protocols	WPA3 / WPA2-PSK (TKIP, AES)

## **GENERAL**

Power Requirement	14.4 V DC (11–16 V allowable)
Operating temperature	-20°C to + 60°C
Power Output	50 W × 4
Maximum Current Consumption	15 A
Audio output level	
Preout (Front, Rear):	4V/10k ohms (max.)
Preout (Subwoofer):	4V/10k ohms (max.)
Weight	1.4 kg (iLX-507A) 2.3 kg (iLX-F509A) 2.6 kg (iLX-F511A)

## **CHASSIS SIZE**

	iLX-507A	iLX-F509A	iLX-F511A
Width	178 mm	178 mm	178 mm
Height	50 mm	50 mm	50 mm
Depth	149.6 mm	149.6 mm	149.6 mm

## **DISPLAY SIZE**

	iLX-507A	iLX-F509A	iLX-F511A
Width	171 mm	232.5 mm	268.9 mm
Height	96 mm	151.1 mm	178 mm
Depth	17.7 mm	54.7 mm	54.7 mm

- *Due to continuous product improvement, specifications and design are subject to change without notice.*
- *The LCD panel is manufactured using an extremely high precision manufacturing technology. Its effective pixel ratio is over 99.99%. This means that there is a possibility that 0.01% of the pixels could be either always ON or OFF.*

---

---

# Installation and Connections

Before installing or connecting the unit, please read the following and pages 7 to 8 of this manual thoroughly for proper use.

 **WARNING**

---

**DO NOT DISASSEMBLE OR ALTER.**

Doing so may result in an accident, fire or electric shock.

---

**KEEP SMALL OBJECTS SUCH AS SCREWS OUT OF THE REACH OF CHILDREN.**

Swallowing them may result in serious injury. If swallowed, consult a physician immediately.

---

**USE THE CORRECT AMPERE RATING WHEN REPLACING FUSES.**

Failure to do so may result in fire or electric shock.

---

**DO NOT BLOCK VENTS OR RADIATOR PANELS.**

Doing so may cause heat to build up inside and may result in fire.

---

**USE THIS PRODUCT FOR MOBILE 12V APPLICATIONS.**

Use for other than its designed application may result in fire, electric shock or other injury.

---

**MAKE THE CORRECT CONNECTIONS.**

Failure to make the proper connections may result in fire or product damage.

---

**USE ONLY IN CARS WITH A 12 VOLT NEGATIVE GROUND.**

(Check with your dealer if you are not sure.) Failure to do so may result in fire, etc.

---

**BEFORE WIRING, DISCONNECT THE CABLE FROM THE NEGATIVE BATTERY TERMINAL.**

Failure to do so may result in electric shock or injury due to electrical shorts.

---

**DO NOT ALLOW CABLES TO BECOME ENTANGLED IN SURROUNDING OBJECTS.**

Arrange wiring and cables in compliance with the manual to prevent obstructions when driving. Cables or wiring that obstruct or hang up on places such as the steering wheel, gear lever, brake pedals, etc. can be extremely hazardous.

---

**DO NOT SPLICE INTO ELECTRICAL CABLES.**

Never cut away cable insulation to supply power to other equipment. Doing so will exceed the current carrying capacity of the wire and result in fire or electric shock.

---

**DO NOT DAMAGE PIPE OR WIRING WHEN DRILLING HOLES.**

When drilling holes in the chassis for installation, take precautions so as not to contact, damage or obstruct pipes, fuel lines, tanks or electrical wiring. Failure to take such precautions may result in fire.

---

**DO NOT USE BOLTS OR NUTS IN THE BRAKE OR STEERING SYSTEMS TO MAKE GROUND CONNECTIONS.**

Bolts or nuts used for the brake or steering systems (or any other safety-related system), or tanks should NEVER be used for installations or ground connections. Using such parts could disable control of the vehicle and cause fire etc.

---

**DO NOT INSTALL IN LOCATIONS WHICH MIGHT HINDER VEHICLE OPERATION, SUCH AS THE STEERING WHEEL OR SHIFT LEVER.**

Doing so may obstruct forward vision or hamper movement etc. and results in serious accident.

---

**DO NOT INSTALL THE MONITOR NEAR THE PASSENGER SEAT AIR BAG.**

If the unit is not installed correctly the air bag may not function correctly and when triggered the air bag may cause the monitor to spring upwards causing an accident and injuries.

 **CAUTION**

---

**HAVE THE WIRING AND INSTALLATION DONE BY EXPERTS.**

The wiring and installation of this unit requires special technical skill and experience. To ensure safety, always contact the dealer where you purchased this product to have the work done.

---

**USE SPECIFIED ACCESSORY PARTS AND INSTALL THEM SECURELY.**

Be sure to use only the specified accessory parts. Use of other than designated parts may damage this unit internally or may not securely install the unit in place. This may cause parts to become loose resulting in hazards or product failure.

---

**ARRANGE THE WIRING SO IT IS NOT CRIMPED OR PINCHED BY A SHARP METAL EDGE.**

Route the cables and wiring away from moving parts (like the seat rails) or sharp or pointed edges. This will prevent crimping and damage to the wiring. If wiring passes through a hole in metal, use a rubber grommet to prevent the wire's insulation from being cut by the metal edge of the hole.

---

**DO NOT INSTALL IN LOCATIONS WITH HIGH MOISTURE OR DUST.**

Avoid installing the unit in locations with high incidence of moisture or dust. Moisture or dust that penetrates into this unit may result in product failure.

# Precautions

- Be sure to disconnect the cable from the (-) battery post before installing your unit. This will reduce any chance of damage to the unit in case of a short-circuit.
- Be sure to connect the color coded leads according to the diagram. Incorrect connections may cause the unit to malfunction or damage to the vehicle's electrical system.
- When making connections to the vehicle's electrical system, be aware of the factory installed components (e.g. on-board computer). Do not tap into these leads to provide power for this unit. When connecting the unit to the fuse box, make sure the fuse for the intended circuit of the unit has the appropriate amperage. When in doubt, consult your Alpine dealer.
- The unit uses female RCA-type jacks for connection to other units (e.g. amplifier) having RCA connectors. You may need an adaptor to connect other units. If so, please contact your authorized Alpine dealer for assistance.
- Be sure to connect the speaker (-) leads to the speaker (-) terminal. Never connect left and right channel speaker cables to each other or to the vehicle body.

## Accessory List

### ■ iLX-507A

Main unit .....	1
Quick Reference Guide.....	1 set

#### <Cables>

Power cable .....	1
GPS Antenna .....	1
Antenna mounting plate.....	1
Cable clamp for antenna .....	1 set
USB extension cable.....	1
PRE OUT cable .....	1
Microphone.....	1
CAMERA cable.....	1
REMOTE cable.....	1

#### <Main unit mounting parts>

Face Plate.....	1
HDMI Bracket .....	1
Flush head screw (M5×8).....	4
Screw (M5×8).....	4

### ■ iLX-F509A/iLX-F511A

Main unit .....	1
Display unit.....	1
Quick Reference Guide.....	1 set

#### <Cables>

Power cable .....	1
GPS Antenna .....	1
Antenna mounting plate.....	1
Cable clamp for antenna .....	1 set
PRE OUT cable .....	1
Microphone.....	1
CAMERA cable.....	1
REMOTE cable.....	1

#### <Main unit mounting parts>

HDMI Bracket.....	1
Flush head screw (M5×8).....	4
Screw (M5×8).....	4

#### <Display unit mounting parts>

Cover Rear .....	1
Cover Hinge.....	1
Power Plate.....	1
Sheet Rear (2×50).....	2
Sheet Rear (2×35).....	2
Sheet Rear (2×20).....	4
Sheet Hinge.....	2
Sheet cap.....	2
Screw (M5×8).....	4
Screw (M3×4).....	2
Screw Bind (M2.6×6).....	2

## Installation

### Mounting (iLX-F509A/iLX-F511A only)

Consult "Position Adjustment and Mounting Dimensions of the Display" (page 80) in advance so that this unit does not obstruct your field of vision or impair driving when mounted.

### Caution

- Do not block the unit's fan, thus preventing air circulation. If blocked, heat will accumulate inside the unit and may cause a fire.

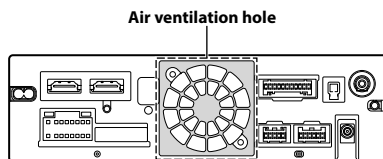

Rear of the Unit

- When installing the display unit and main unit, do not touch the connectors with your hands. (iLX-F509A/iLX-F511A only)

#### <Display unit>

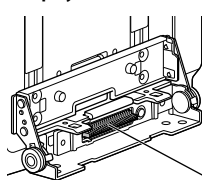

#### <Main unit>

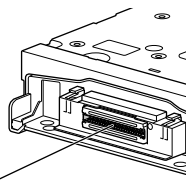

Connectors

## Caution concerning the installation location

### Angle of installation

Install at an angle between horizontal and 30°. Note that installing at an angle outside of this range will result in a loss of performance and possibly damage.

#### ■ iLX-507A

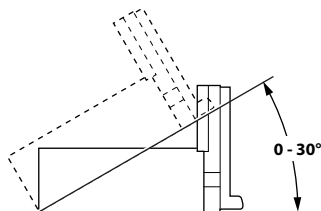

#### ■ iLX-F509A/iLX-F511A

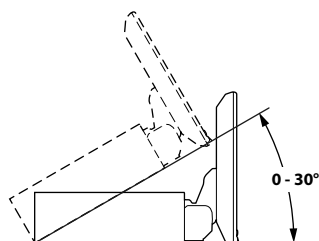

## Mounting the Microphone

For safe use, make sure of the following:

- Location is stable and firm.
- Does not interfere with safety equipment.
- Driver's view and operations are not obstructed.
- Microphone is located where the driver's voice can be easily picked up.

When you speak into the microphone, you should not have to change your driving posture. This may cause a distraction, taking your attention away from safely driving your vehicle. Carefully consider direction and distance while mounting the microphone. Confirm that the driver's voice can be easily picked up at the selected location.

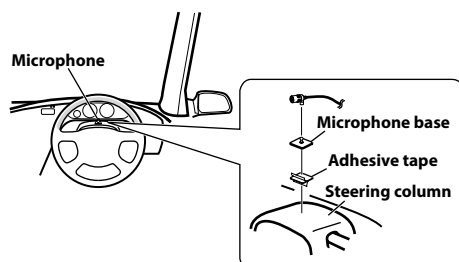

## Mounting the GPS Antenna inside the vehicle

- 1 Clean the mounting location.
- 2 Put on the GPS Antenna mounting plate.
- 3 Mount the GPS Antenna.

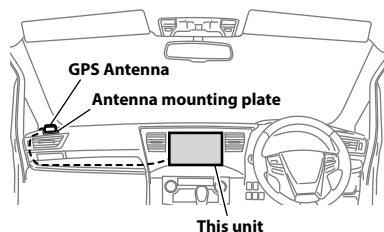

- Do not mount the GPS Antenna inside the centre console.
  - Mount the GPS Antenna on a flat plane of the dash board or rear tray.
  - Make sure the GPS Antenna is not covered (obstructed) by any metallic surface or object.
- If the GPS Antenna is mounted near the unit, the reception becomes poor, and the location of your vehicle may not be displayed correctly.
  - Mount the GPS Antenna far away enough from the unit.
  - Bundle the GPS Antenna cable away from the rear of the unit.
- Some thermal reflection type or thermal absorption type glass may interrupt high frequency waves. If reception is poor with the antenna installed inside the car, try to mount the antenna outside the car.

## Note on using HDMI Connection Cables

When using HDMI connection cables, secure the cables to the HDMI Terminals with the supplied HDMI Fixation Bracket.

### Secure the HDMI Fixation Bracket with the screw (A).

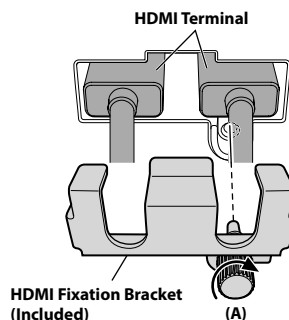

## Position Adjustment and Mounting Dimensions of the Display (iLX-F509A/iLX-F511A only)

The mounting position of this unit's Display can be adjusted (front-back/angle). When mounting the Display, confirm the mounting position and mounting dimensions so that it does not obstruct your field of vision or impair driving.

### WARNING

- In the following cases, the display cannot be mounted.
  - It impairs operation of the steering wheel or various levers (gearshift, windshield wiper switch, turn signal switch, etc.)
  - It impairs operation of the airbag
  - It significantly impairs operation of the hazard switch
  - It impairs identification or operation of any other control switches
  - It impairs confirmation of gauges or warning indicators
  - It interferes with vehicle equipment (switches, panels, etc.)
- \* Depending on the vehicle, the glove compartment or cup holders may become inaccessible, or air conditioner ventilation ducts may be covered.

### ■ Display mounting dimensions and adjustable positions

#### Front-back position

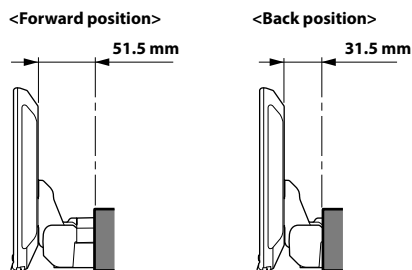

#### Adjustable Display angle

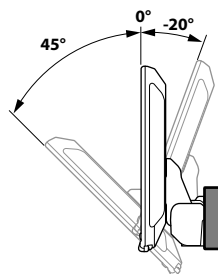

- To adjust the display angle, hold the center of the top and bottom of the display to move it. To protect the display, do not hold the left and right ends to move it.

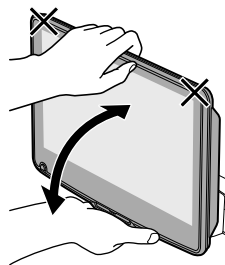

### CAUTION

Do not adjust the display angle when the display unit is not fixed to the slider of the main unit using 4 screws (M5×8). Doing so may not turn power on.

#### Adjustable Display up-down position

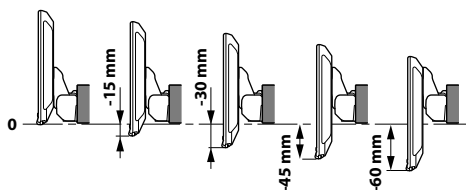



## Adjusting the display position (iLX-F509A/iLX-F511A)

Depending on the vehicle, the front-back display position differs. To adjust the front-back position, set the slider to the forward position.

Default setting: Back position

- 1 Remove 4 hexagon bolts from both sides of the unit.**

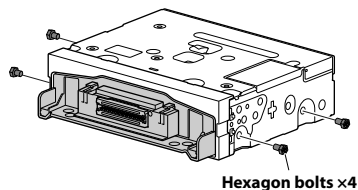

- 2 Pull out the slider to the forward position. (To return the slider to the back position, push it in.)**

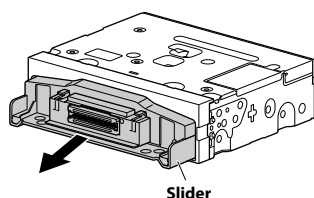

- 3 Install 4 hexagon bolts to secure the slider.**

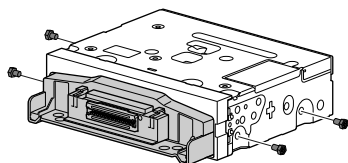

## Installation example using the Original Mounting Bracket

- 1 Mount the original mounting bracket to the unit using the supplied screws.**

- If you do not have the original mounting bracket, mount the Double din KIT\* (provided with the side mounting bracket), etc. to the main unit.

\* Sold separately.

### ■ iLX-507A

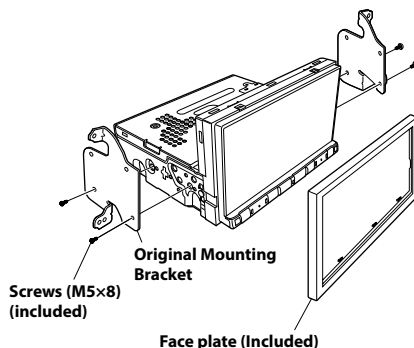

### ■ iLX-F509A/iLX-F511A

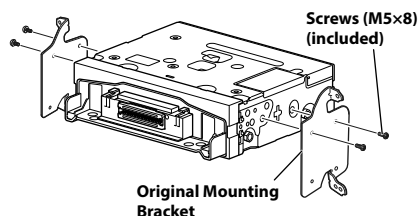

- 2 Connect all other leads of the unit according to details described in the "Connections" (page 84).**

- 3 Mount the unit in a car.**

- Fix the cables carefully. Do not damage them by mounting them into movable parts, such as the seat rail, or by locating them against sharp or pointed edges.

- 4 Reattach the removed vehicle parts (panels, etc.) or other aftermarket dash kit back onto the vehicle.**

## Adjust the up-down position of the Display unit (iLX-F509A/iLX-F511A)

Adjust the up-down position of the display according to the mounting position on the vehicle before mounting the display unit.

Default setting: 0 mm

- 1 Remove the 4 screws on the rear of the display unit, then adjust the up-down position.

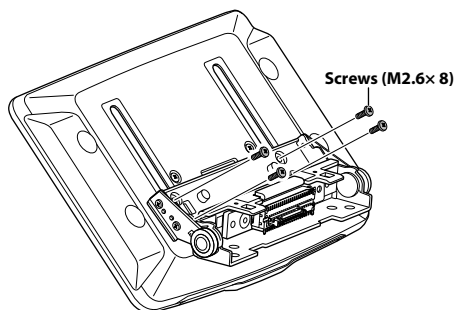

When the vertical position of the display unit is decided, fix it with the 4 screws you removed.

- 2 Attach the Sheet Rear in a position that aligns with the up-down position of the display unit.

Sheet Rear (Included)	up-down position
2x50 mm:	for up-down position 0 mm or -60 mm
2x35 mm:	for up-down position -15 mm or -45 mm
2x20 mm:	for up-down position -30 mm

0 mm

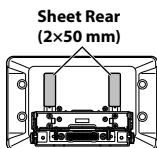

-15 mm

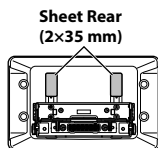

-30 mm

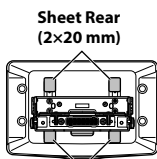

-45 mm

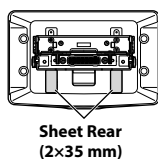

Sheet Rear (2x20 mm)

-60 mm

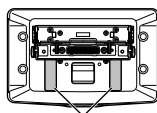

Sheet Rear (2x50 mm)

- 3 Attach the Cover Rear to the rear of the display unit using 2 screws (M2.6x6). Secure the screws, then attach the Sheet caps.

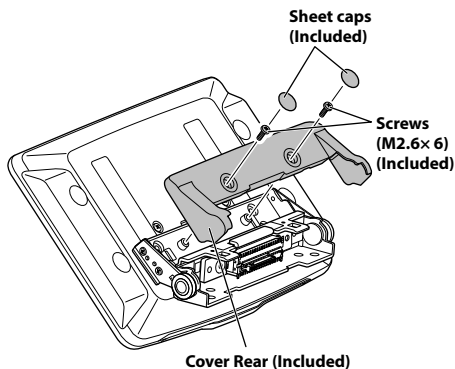

## Install the display unit (iLX-F509A/iLX-F511A)

- 1 Fix the Display unit to the slider of the main unit using 4 screws (M5x8).

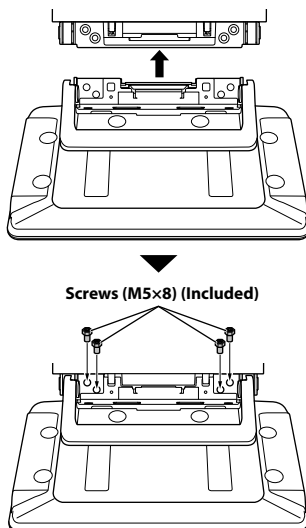

**⚠ CAUTION**

Do not adjust the display angle when the display unit is not fixed to the slider of the main unit using 4 screws (M5×8). Doing so may not turn power on.

**2 Mount the Power Plate.**

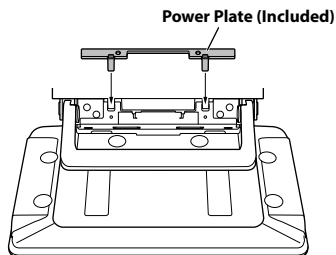

- If the Power Plate is not mounted, the display unit may not be turned power on. Make sure to mount it.

**3 Mount the Cover Hinge using 2 screws (M3×4).  
Secure the screws, then attach the Sheet Hinge.**

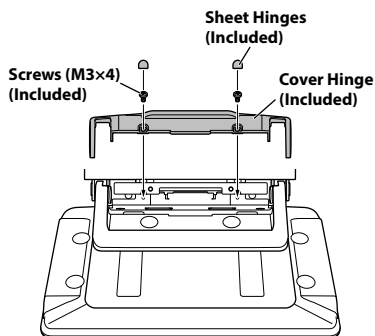

# Connections

## Connection 1

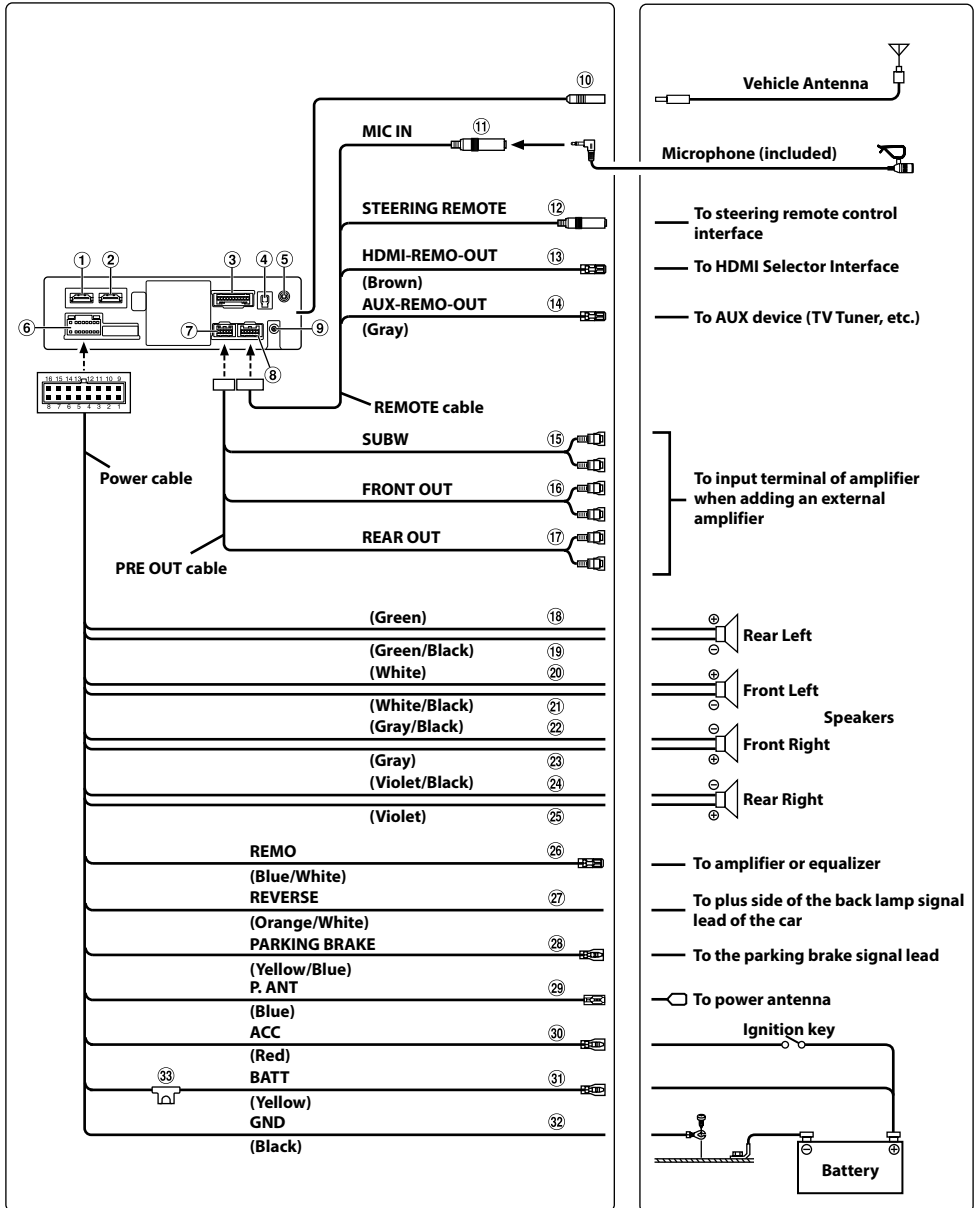

## Connection 2

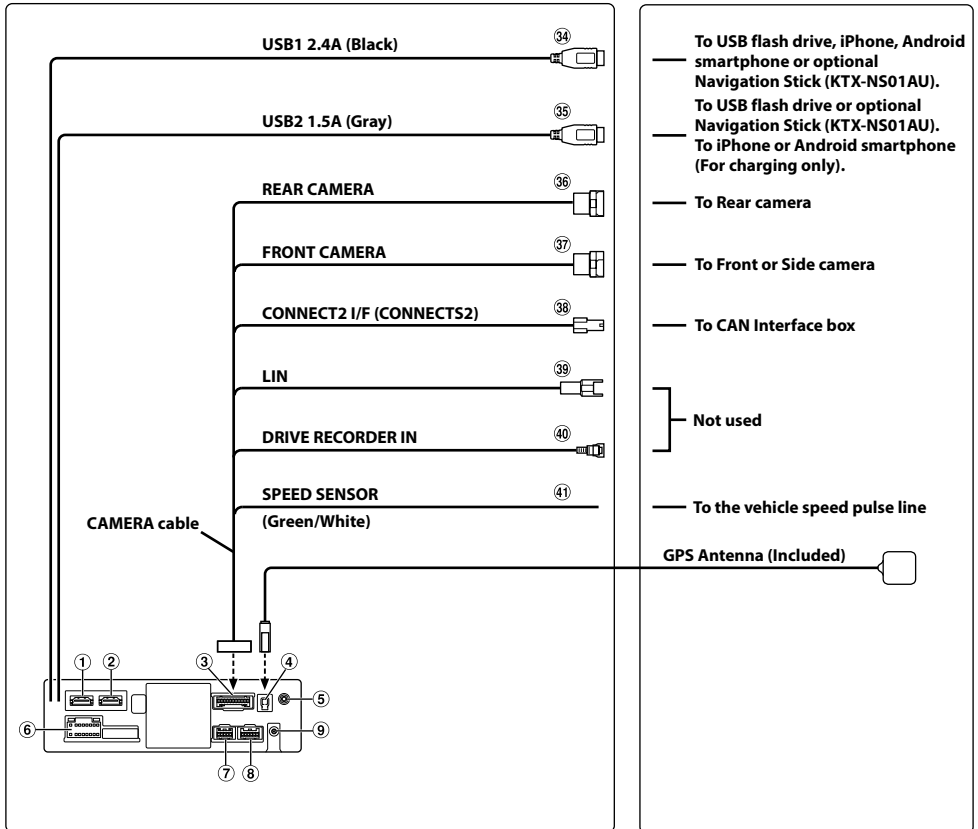

- ① HDMI Input Connector
- ② HDMI Output Connector
- ③ CAMERA Connector
- ④ GPS Antenna Receptacle  
Connect to GPS antenna (Included).
- ⑤ AUX Input Connector  
Input lead for AUX audio signal.
- ⑥ Power Supply Connector
- ⑦ PRE OUT Connector
- ⑧ REM Connector
- ⑨ DAB Antenna Connector  
To DAB Antenna (sold separately).
- ⑩ Radio Antenna Receptacle
- ⑪ MIC Input Connector  
To microphone (included).
- ⑫ Steering Remote Control Interface Connector  
To steering remote control interface.  
For details about connections, consult your nearest Alpine dealer.
- ⑬ HDMI-REM-OUT Lead (Brown)  
Connect this lead to the remote input lead of your HDMI Selector Interface.
- ⑭ AUX-REM-OUT Lead (Gray)  
Connect this lead to the remote input lead of your AUX device.
- ⑮ Subwoofer RCA Connectors  
RED is right and WHITE is left.
- ⑯ Front Output RCA Connectors  
Can be used as Front Output RCA Connectors. RED is right and WHITE is left.
- ⑰ Rear Output RCA Connectors  
Can be used as Rear Output RCA Connectors. RED is right and WHITE is left.

- ⑮ Left Rear (+) Speaker Output Lead (Green)
- ⑯ Left Rear (-) Speaker Output Lead (Green/Black)
- ⑰ Left Front (+) Speaker Output Lead (White)
- ⑱ Left Front (-) Speaker Output Lead (White/Black)
- ⑲ Right Front (-) Speaker Output Lead (Gray/Black)
- ⑳ Right Front (+) Speaker Output Lead (Gray)
- ㉑ Right Rear (-) Speaker Output Lead (Violet/Black)
- ㉒ Right Rear (+) Speaker Output Lead (Violet)
- ㉓ Remote Turn-On Lead (Blue/White)  
Connect this lead to the remote turn-on lead of your amplifier or signal processor.
- ㉔ Reverse Lead (Orange/White)
- ㉕ Parking Brake Lead (Yellow/Blue)  
Connect this lead to the power supply side of parking brake switch to transmit the parking brake status signals to the unit.
- ㉖ Power Antenna Lead (Blue)  
Connect this lead to the +B terminal of your power antenna, if applicable.  
\* This lead should be used only for controlling the vehicle's power antenna. Do not use this lead to turn on an amplifier or a signal processor, etc.
- ㉗ Switched Power Lead (Ignition) (Red)  
Connect this lead to an open terminal on the vehicle's fuse box or another unused power source that provides (+) 12V only when the ignition is turned on or in the accessory position.
- ㉘ Battery Lead (Yellow)  
Connect this lead to the positive (+) post of the vehicle's battery.
- ㉙ Ground Lead (Black)  
Connect this lead to a good chassis ground on the vehicle.  
Make sure the connection is made to bare metal and is securely fastened using the sheet metal screw provided.
- ㉚ Fuse Holder (15A)
- ㉛ USB1 Connector 2.4A (Black)  
To USB flash drive, iPhone, Android smartphone or optional Navigation Stick (KTX-NS01AU).
- ㉜ USB2 Connector 1.5A (Gray)  
To USB flash drive or optional Navigation Stick (KTX-NS01AU).  
To iPhone or Android smartphone (For charging only).
- ㉝ REAR CAMERA Input Connector  
Used when connecting the optional rear camera.
- ㉞ FRONT CAMERA Input Connector  
Use when connecting the optional front camera or side cameras (and Multi Camera Selector Interface module).
- ㉟ Connects2 Connector  
To Interface Box.
- ㊱ LIN Connector  
Not used.

- ㊲ Drive Recorder Input Connector  
Not used.
- ㊳ Speed Sensor Lead (Green/White)  
Improper connection of the speed pulse line may cause important safety features of the vehicle to fail (such as the brakes or air bags). Such failures may result in an accident and loss of life. We strongly recommend that the installation be performed by a trained, authorized Alpine dealer.

### **Usable AV/RCA Interface Cable (4-pole mini AV plug to 3-RCA)**

Wiring convention of this system is as follows;

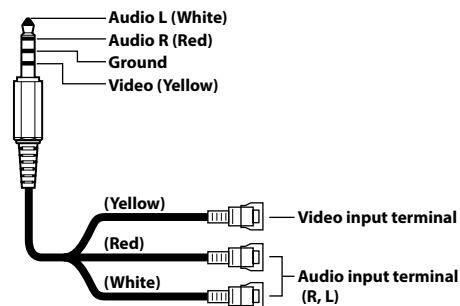

- Configuration commercially available 4-pole mini AV plugs is not standardised.

## If an ACC power supply is not available

### Connection Diagram of SPST Switch (sold separately)

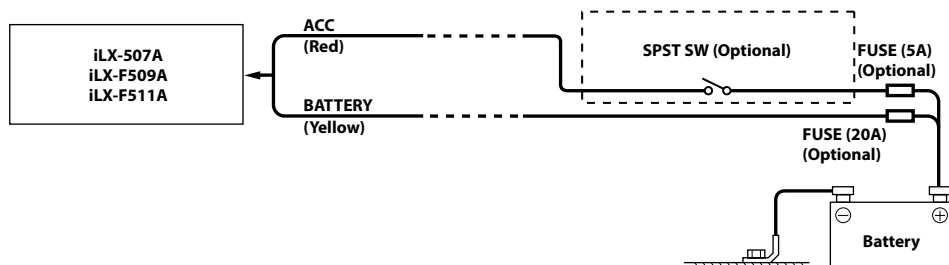

- If your vehicle has no ACC power supply, add an SPST (single-pole, single-throw) switch (sold separately) and fuse (sold separately).
- The diagram and the fuse amperage shown above are in the case when the unit is used individually.
- If the switched power (ignition) lead of the unit is connected directly to the positive (+) post of the vehicle's battery, the unit draws some current (several hundred milliamperes) even when its switch is placed in the OFF position, and the battery may be discharged.

#### To prevent external noise from entering the audio system.

- Locate the unit and route the leads at least 10 cm away from the car harness.
- Keep the battery power leads as far away from other leads as possible.
- Connect the ground lead securely to a bare metal spot (remove any paint, dirt or grease if necessary) of the car chassis.
- If you add an optional noise suppressor, connect it as far away from the unit as possible. Your Alpine dealer carries various noise suppressors, contact them for further information.
- Your Alpine dealer knows best about noise prevention measures so consult your dealer for further information.

## System Example

### Connection of an iPhone

#### ■ When connecting to an iPhone with a Lightning connector

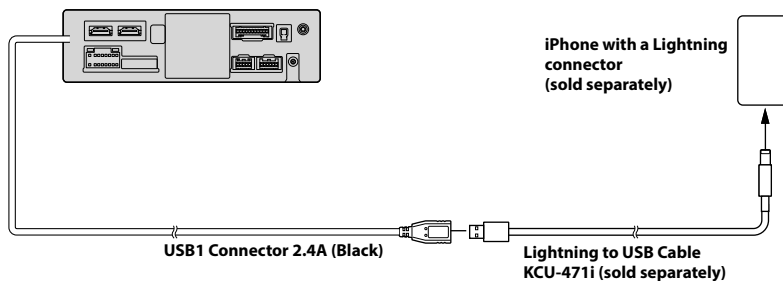

- Do not leave an iPhone in a vehicle for a long time. Heat and humidity may damage the iPhone, and you may not be able to play it again.

### Connection of a USB Flash Drive

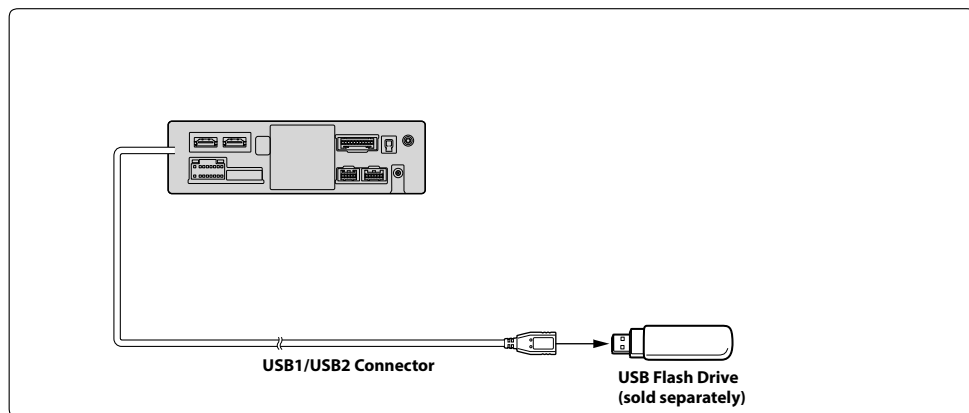

- Do not leave a flash drive in a vehicle for a long time. Heat and humidity may damage the flash drive.



### Connection of an HDMI Device (iPhone with a Lightning connector)

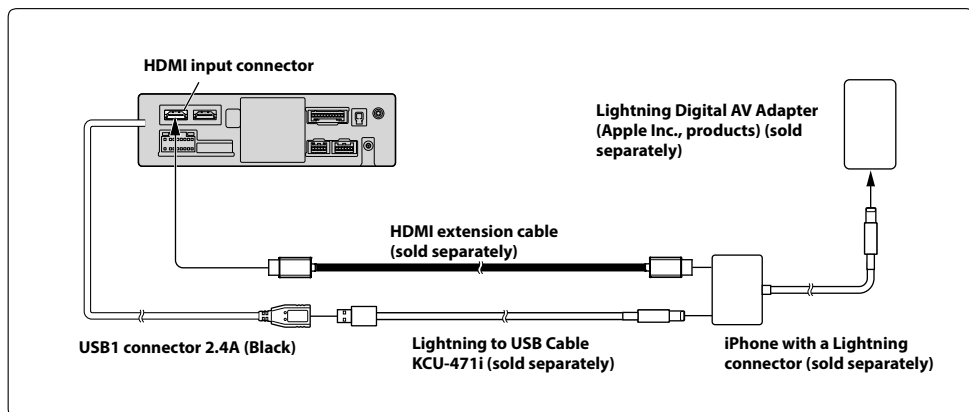

### Connection of an HDMI Device (Android device)

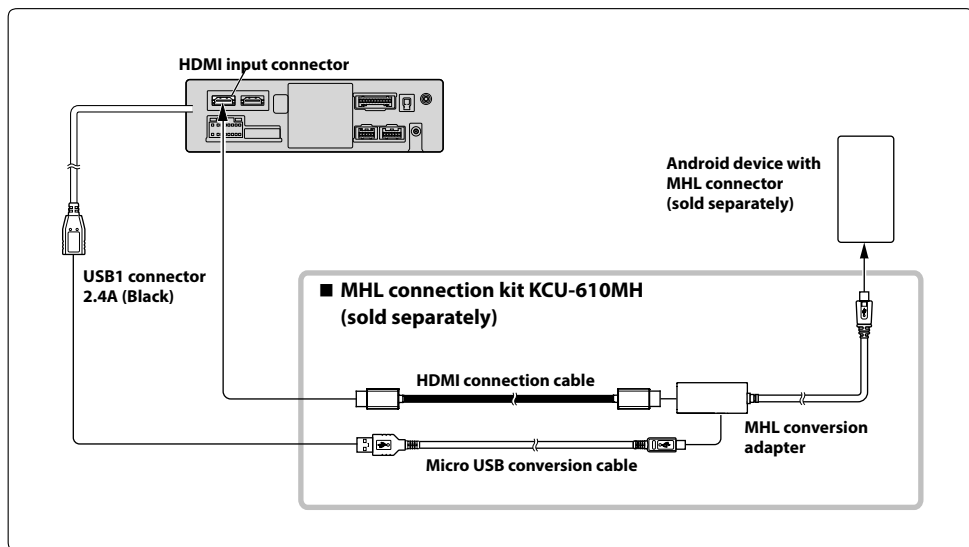

- A connection kit or adapter kit suitable for the type of terminal on the connecting device is required.

## Connection of an HDMI Device (using HDMI SELECTOR INTERFACE)

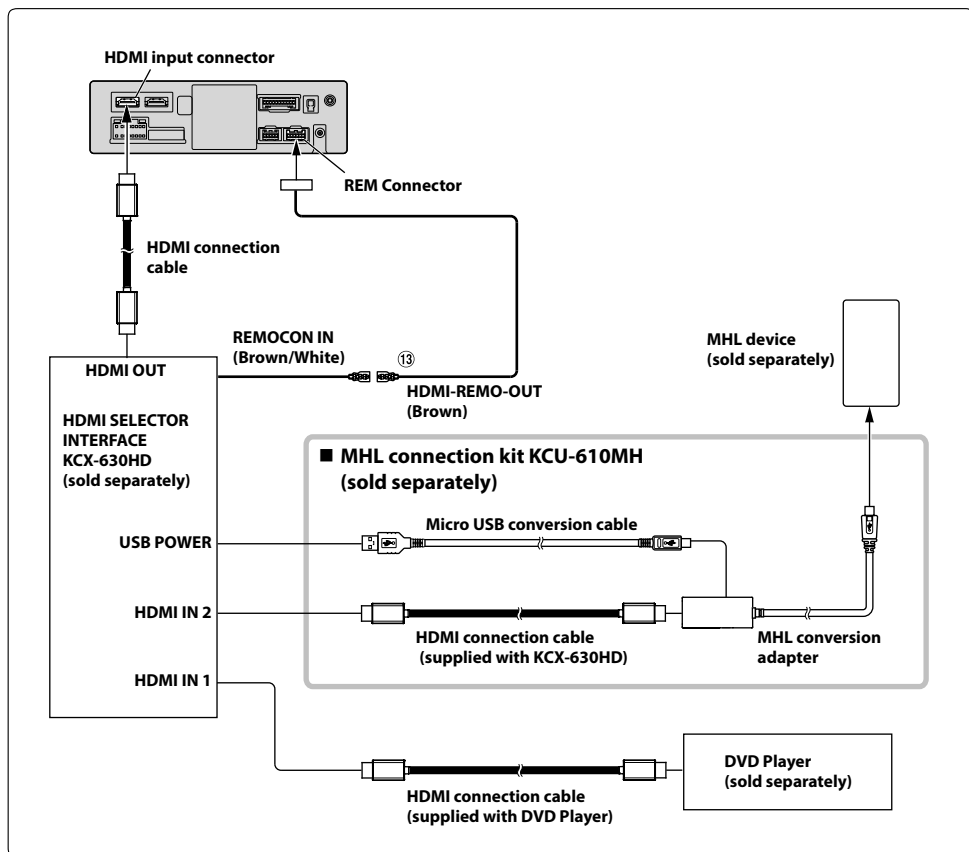

⑬ HDMI-REM-OUT Lead (Brown)

- A connection kit or adapter kit suitable for the type of terminal on the connecting device is required.

## Connection of an External Device

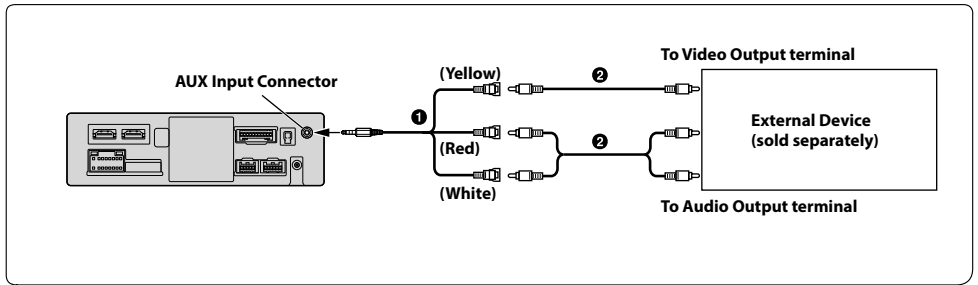

- ❶ AV/RCA Interface Cable (4-pole mini AV plug to 3-RCA) (sold separately)
- ❷ RCA Extension Cable (sold separately)

• You can change the name of an external device. For details, refer to “Setting the Auxiliary (AUX) Name” (page 22).

## Connection of an External Amplifier

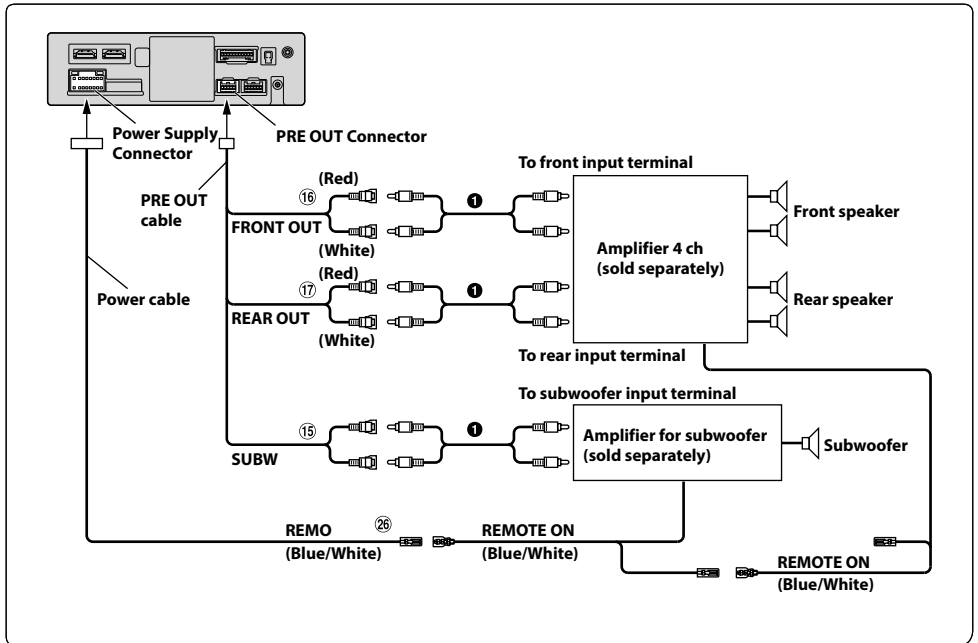

- ❶ Subwoofer RCA Connectors
- ❷ Front Output RCA Connectors
- ❸ Rear Output RCA Connectors
- ❹ Remote Turn-On Lead (Blue/White)
- ❺ RCA Extension Cable (sold separately)

## Connection of a Camera

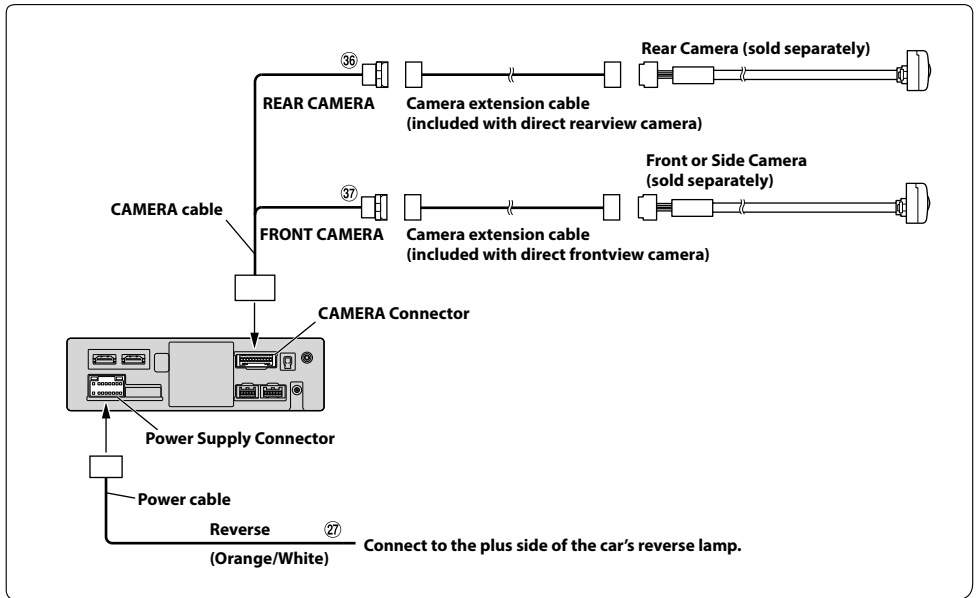

②⑦ Reverse Lead (Orange/White)

③⑦ FRONT CAMERA Input Connector

③⑥ REAR CAMERA Input Connector

- When using the optional Multi Camera Interface module, you can connect up to 3 cameras: Front camera, Rear camera, and Side camera. For details on how to connect, refer to the OWNER'S MANUAL of the Multi Camera Interface module (KCX-C250MC).